

www.projectcollection.co.uk



21 / 22

project

collection

recessed / recessed plaster / track & spot / led strip /
ceiling / wall / wall plaster / wall shades / wall lights /
reading lights / table & floor / shades / outdoor /

project

collection

.....

the 2021 Project Collection is developed with you the 'specifier' in mind. Providing a single solution that will enable you to effectively specify lighting for your project requirements and the task at hand.

contents

recessed

11



zeus LED 🔥💧

12



zeus GU10 🔥💧

13



hera

14



slim trim adjustable FR 🔥

15



slim trim adjustable

16



slim trim IP65 FR 🔥💧

17



slim trim IP65 💧

18-19



glacier 💧 / wall washer

20-21



grid WW / WB / SB / BB

22



grid FR 🔥

23-25



grid FR 🔥 / slim trimless 💧

26-29

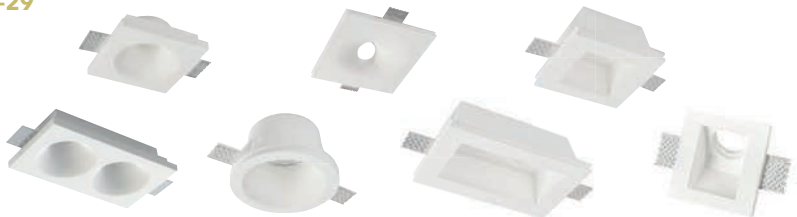

plaster downlights

30-37



recessed wall lights

38-39



marker lights 💧

track & spot

40-49



track, track heads and accessories

50-53



moon

54-55



selene

56-57



apollo

58-59



jupiter

led strip

60-65



led strip / IP65

66-69

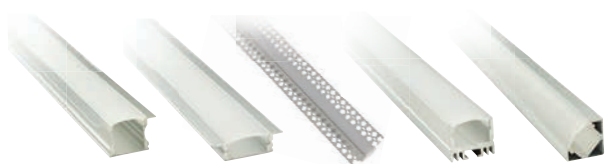

aluminium profile and drivers

ceiling

72



ara pendant 100

73



ara pendant 60

74



compass 2

75



orbit 120

76-77



eternity 78 / 55 pendant

contents

ceiling

77



eternity 55 flush

78-79



hepburn

80



clip pendant

81



lino pendant

82



athena pendant

83



artemis

83



apollo pendant

84-85



honos / andromeda

86-87



orca / saturn

88



banda 

89



andaman 

90



lyra

91



vulcan

92-93



corona 

94



blob pendant

95



blob flush

96



3 light semi-flush

96



3 light -suspension

97



1lt suspension

wall

100-101



sloane

102-103



southwark

102-103



shoreditch

104



ice

105



halkin

106-107



london bridge

108-109



vavin

110-111



veritas / venti 

112-113



tube / ovo

116



concorde

117



europe

118-119



sentier / mirabeau / monceau

120-121



mabillon / avron

122-123



cadet / voltaire

124



cambronne

125



odeon / opera

126-127



mini projector

128-129



universal shades

128



universal wall bracket

contents

wall

130-131



pimlico / reader

132-133



pimlico plus / reader

134



fenchurch

135



victoria / reader

136



victoria LED

137



victoria LED recessed

138-139



chelsea

187



acqua

table & floor

142-143



libra

144-145



kensington

146-147



olympia

shades

152-155



shades

outdoor

158-159



strand / mayfair

160-161



berkeley

162-163



claridges / lanesborough

164-165



waldorf / connaught

166



dorchester

167



sanderson

168



grosvenor

169



grosvenor II

170-171



farrington

172-173



plot light

174



piccadilly

175



paddington

176-177



euston / hood

178-179

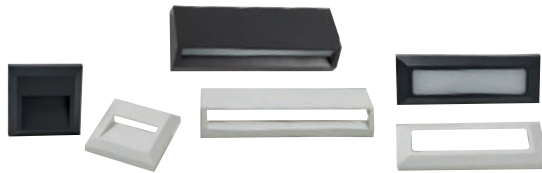

sapporo / suzuka

180-181



yokohama

182



chiba duo

183



tokyo

184



kobe

185



kyoto





recessed

zeus features



Benefits and features of the 'Zeus' All-in-One Universal Downlight:

- **Fire Rated** - Tested in 30, 60 and 90-minute fire-rated ceilings.
- **IP65** - Can be specified in bathrooms over shower / bath.
- **20° Tilt** - Can be used in a fixed or tilted orientation.
- **Anti-Glare** - Light source is set back from the face of the fitting.
- **Integrated Design** - Enables effective heat dissipation.
- **Dimmable** - Smooth and linear dimming.
- **Cameta™ Lens** - Provides high transparency and even light output.
- **Part L Compliant** - Adheres to the energy efficiency requirements of Part L of the Buildings Regulations.

driver

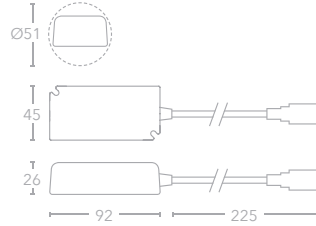

Key Features

- UL 94 V0 fire resistant polycarbonate housing
- Loop in and loop out
- Up to 8A Max. current
- Glow wire: 650°C approved
- Compatible with dimmers
- No tools required



CREE COB LED
SDCM<3
Sharp Target
2000K - 3000K
Dim to Warm

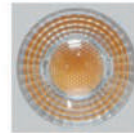

Cameta Lens
High transparency
Even light
protects the eye



Rubycon capacitor
Ensures good quality



Easy driver installation
Loop in and loop out design



DL-ZEUS3K



zeus 3000K

DL-ZEUS3K
 8.5W CREE COB 3000K ●
 700 lumens

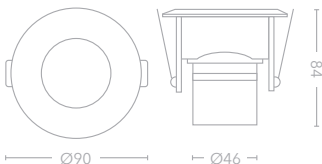

zeus sunset

DL-ZEUSSUNSET
 8.5W Sharp COB 2000-2800K ●
 580 lumens

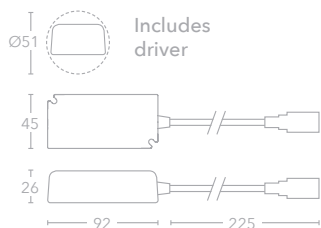

CLASS 3



FIRE RATED



IP 65



DIMMABLE

Key Features

- Matt white finish /
- Aluminium / Carbon steel /
- Fireproof borosilicate glass
- Beam angle: 38° / 20° Tilt
- Power factor: 0.9 / 220-240V
- Anti-glare
- Bathroom zones 1 & 2, driver included
- Interchangeable bezel -
- See next page



DL-ZEUSGU10 / DL-ZEUSGU10BK

FIRE RATED



DL-ZEUSGU10



DL-ZEUSGU10BK





DL-UNIRPC / DL-UNIRSN

zeus GU10

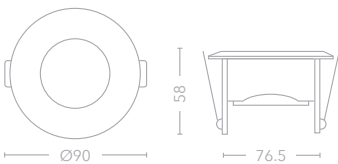
- DL-ZEUSGU10
- DL-ZEUSGU10BK

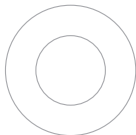

accessories

- DL-UNIRPC  Polished chrome
Bezel only 
- DL-UNIRSN  Satin nickel
Bezel only 

- DL-UNISPG Spare clip, gasket
& glass

-  CLASS 2
-  FIRE RATED
-  IP 65
-  DIMMABLE

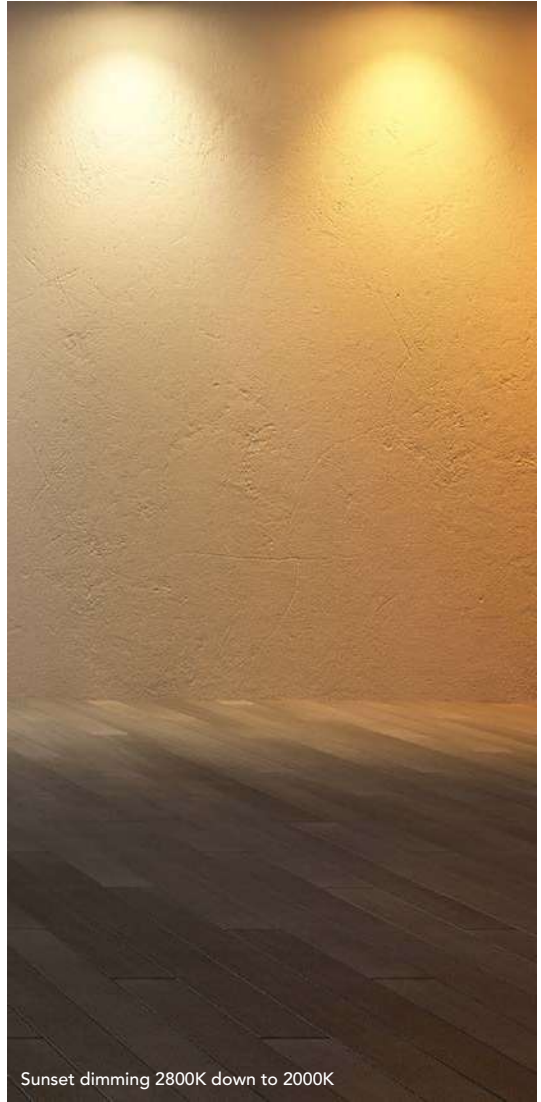

Key Features

- Matt painted finish / Aluminium / Carbon steel
- Fireproof borosilicate glass
- 220-240V / Anti-glare
- 20° Tilt
- Bathroom zones 1 & 2
- Interchangeable bezel



 Products with this icon next to them are compatible with the Hera range of LED modules.

hera

DL-MOD13K		CREE COB 3000K	700 lumens
DL-MOD14K		CREE COB 4000K	750 lumens
DL-MOD2D2W		SHARP COB 2800-2000K	580 lumens

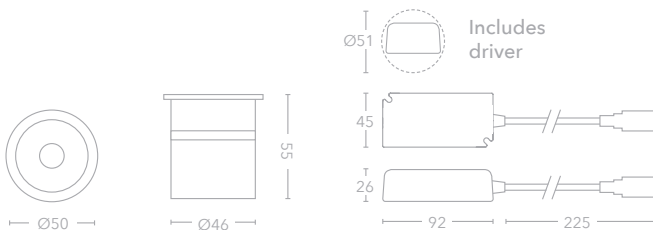

Key Features

Aluminium / White painted finish

8.5W / CRI >80

Beam angle: 38°

Power factor: 0.9 / 220-240V

Can be used as a replacement for a GU10 cap MR16 lamp shape on most fittings

Comes with dimmable driver, loop in loop out terminals



DL-SLIMFRW

slim trim adjustable FR



DL-SLIMFRW 40° Tilt

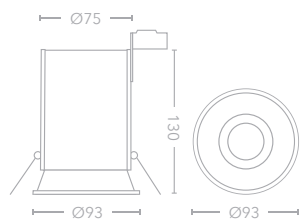

DL-SLIMFRW



CLASS 1



DIMMABLE

Key Features

Matt white finish

220-240V / Max 10W LED only

Anti-glare / 15° Tilt

GU10 lampholder

Fire Rated - Tested in 30, 60 and 90 minute ceilings



slim trim square adjustable



slim trim adjustable

- DL-SLIMSQB 40° Tilt ■
- DL-SLIMSQW 40° Tilt □

- DL-SLIMB 40° Tilt ■
- DL-SLIMW 40° Tilt □

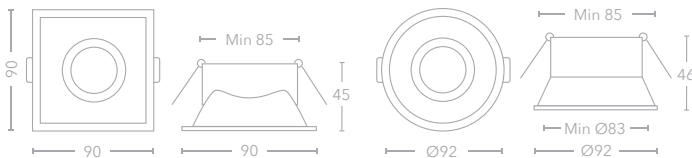

CLASS 2



DIMMABLE

Key Features

- Matt white finish / Die cast body
- 220-240V / Max 10W LED only
- Anti-glare / 15° Tilt
- GU10 lampholder



NEW



DL-SLIMFRW 

 FIRE RATED

slim trim
IP65 FR



NEW



CLASS 1



DIMMABLE



IP 65

DL-SLIMIPFRW 



CUT OUT
75mm

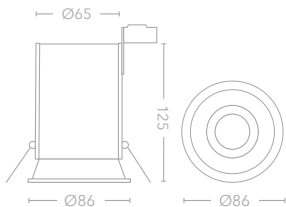

DL-SLIMIPFRW 

Key Features

Matt white finish

220-240V / Max 10W LED only

Anti-glare

GU10 lampholder

Fire Rated - Tested in 30, 60 and 90 minute ceilings



DL-SLIMIPW

recessed



DL-SLIMIPB

DL-SLIMIPW

slim trim
IP65



- DL-SLIMIPB
- DL-SLIMIPW

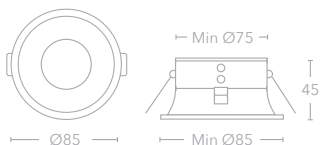

CLASS 2



DIMMABLE



IP
65

Key Features

Matt white finish / Die cast body

220-240V / Max 10W LED only

Anti-glare

GU10 lampholder



Compatible with
Hera module



DL-GLAR



DL-GLAR

glacier round IP65

DL-GLAR

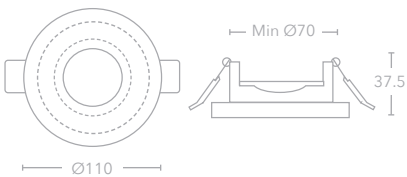

CLASS 2



DIMMABLE



IP 65

Key Features

PMMA & Polished chrome

220-240V

GU10 lampholder

Suitable for use in
Bathroom zones 1 & 2

LED only



DL-WASH



DL-WWW

LED wall washer

DL-WASH 60° Tilt

8W COB LED

Class III



CUT OUT
76mm

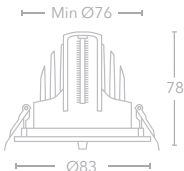

GU10 wall washer

DL-WWW 40° Tilt

Class II



CUT OUT
92mm

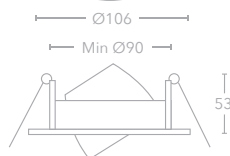
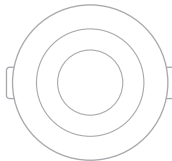

DIMMABLE

Key Features

Sand white finish (LED) / Matt white finish (GU10) / Die cast body

220-240V / Anti-glare

CRI > 80 / 585 lumens (LED)

350° Rotation

Mains dimmable driver included with LED wall washer



DL-GRID1WW



DL-GRID1WB



DL-GRID1BB

grid 1

DL-GRID1WW 

DL-GRID1WB 

DL-GRID1BB 

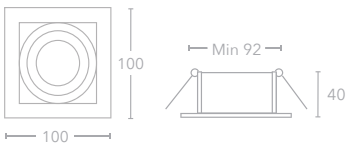

CLASS 2



DIMMABLE

Key Features

Matt painted finish / Die cast body

220-240V

GU10 lampholder

15° Tilt / 360° Rotation

LED only



Compatible with
Hera module



DL-GRID3WW



DL-GRID3WB



DL-GRID3BB



DL-GRID2WW



DL-GRID2WB



DL-GRID2BB

grid 3

- DL-GRID3WW
- DL-GRID3WB
- DL-GRID3BB

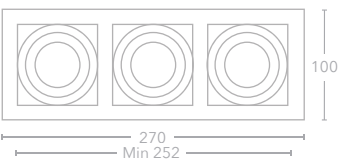

grid 2

- DL-GRID2WW
- DL-GRID2WB
- DL-GRID2BB

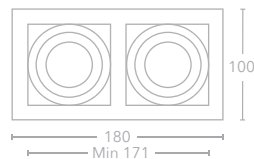

CLASS 2



DIMMABLE

Key Features

Matt painted finish / Die cast body

220-240V

GU10 lampholder

15° Tilt / 360° Rotation

LED only



Compatible with
Hera module

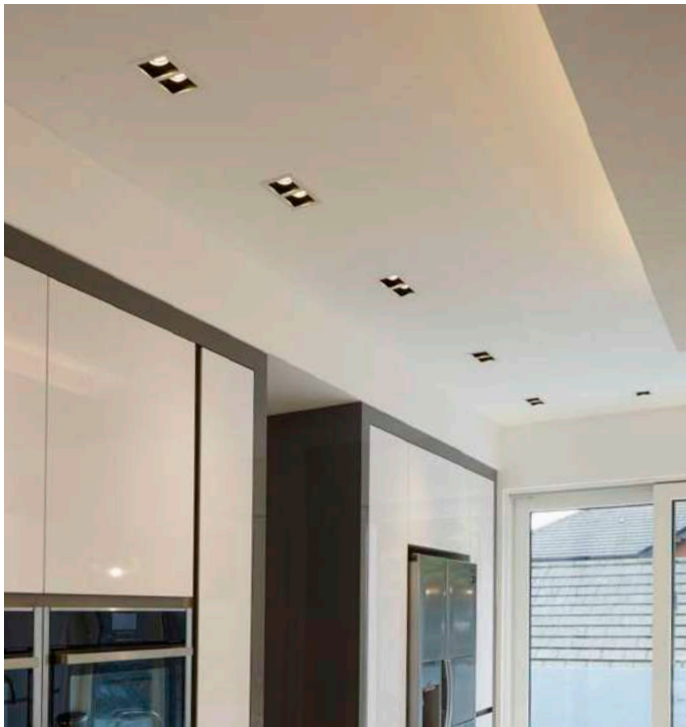

DL-GRID2FRWB 🔥



DL-GRID1FRWW 🔥

grid 1 FR 🔥
FIRE RATED

- DL-GRID1FRWW
- DL-GRID1FRWB

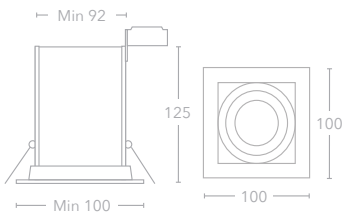

grid 2 FR 🔥 **NEW**
FIRE RATED

- DL-GRID2FRWW
- DL-GRID2FRWB
- DL-GRID2FRBB

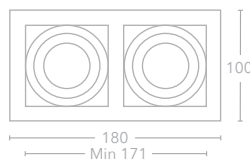

- CLASS 1
- DIMMABLE

Key Features

- Matt painted finish / Die cast body
- 220-240V
- GU10 lampholder
- 15° Tilt / 360° Rotation
- LED only
- Fire Rated - Tested in 30, 60 and 90 minute ceilings



grid 1 FR **trimless** FIRE RATED

PL-GRID1FR

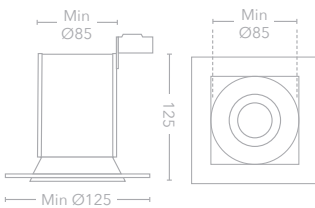

NEW



CLASS 1



DIMMABLE

Key Features

Matt white finish / Die cast body

220-240V / Max 10W LED only

Anti-glare / 15° Tilt

GU10 lampholder

Fire Rated - Tested in 30, 60 and 90 minute ceilings

Ceiling must be skimmed after fitting the item



NEW



NEW



PL-SLIMIPW 



NEW

PL-SLIMW 

slim trimless IP65



PL-SLIMIPW 

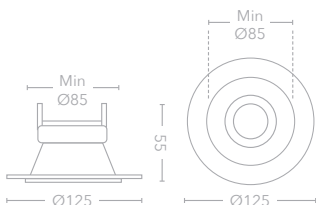

slim trimless adjustable



PL-SLIMW 

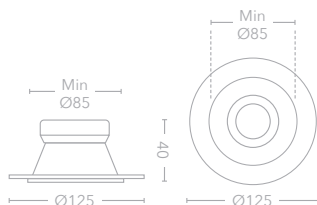

CLASS 2



DIMMABLE

Key Features

Matt white finish / Die cast body

220-240V / Max 10W LED only

Anti-glare / 15° Tilt

GU10 lampholder

Ceiling must be skimmed after fitting the item



Compatible with Hera module

NEW



PL-SLIMFRW 

slim trimless adjustable FR



NEW

PL-SLIMFRW 

Class I



CUT OUT
86mm

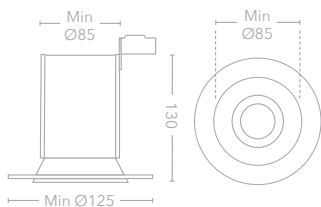

PL-SLIMFRW 



CLASS 1



DIMMABLE

Key Features

Matt white finish / Die cast body

220-240V / Max 10W LED only

Anti-glare / 15° Tilt

GU10 lampholder

Fire Rated - Tested in 30, 60 and 90 minute ceilings

Ceiling must be skimmed after fitting the item



PL-ROM1 / PL-ROM2



PL-ROM2

rome

PL-ROM1 

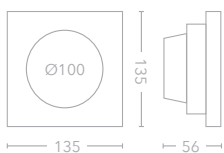

 This symbol represents a white plaster finish

rome twin

PL-ROM2 

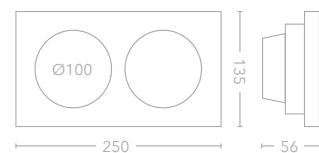

CLASS 1



DIMMABLE



PAINTABLE

Key Features

White plaster

GU10 Class 1 earthed lampholder

Max. 10W LED only

Anti-glare

How to fit guide - See website

Ceiling must be skimmed before fitting the item



recessed / plaster



PL-TROCA



PL-TELEG

trocadero adjustable

PL-TROCA 

Tilt angle: 40°

 Check website for CUT OUT size

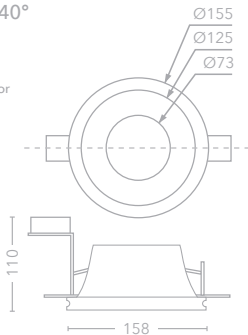

telegraphe wall washer

PL-TELEG 

Lamp angle: 45°

 CUT OUT 222x222mm

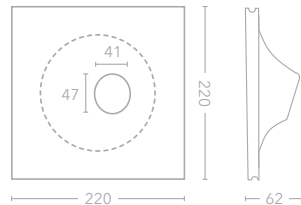

CLASS 1



DIMMABLE



PAINTABLE

Key Features

White plaster

GU10 Class 1 earthed lampholder

Max. 10W LED only

Anti-glare

How to fit guide - See website

Ceiling must be skimmed before fitting the item

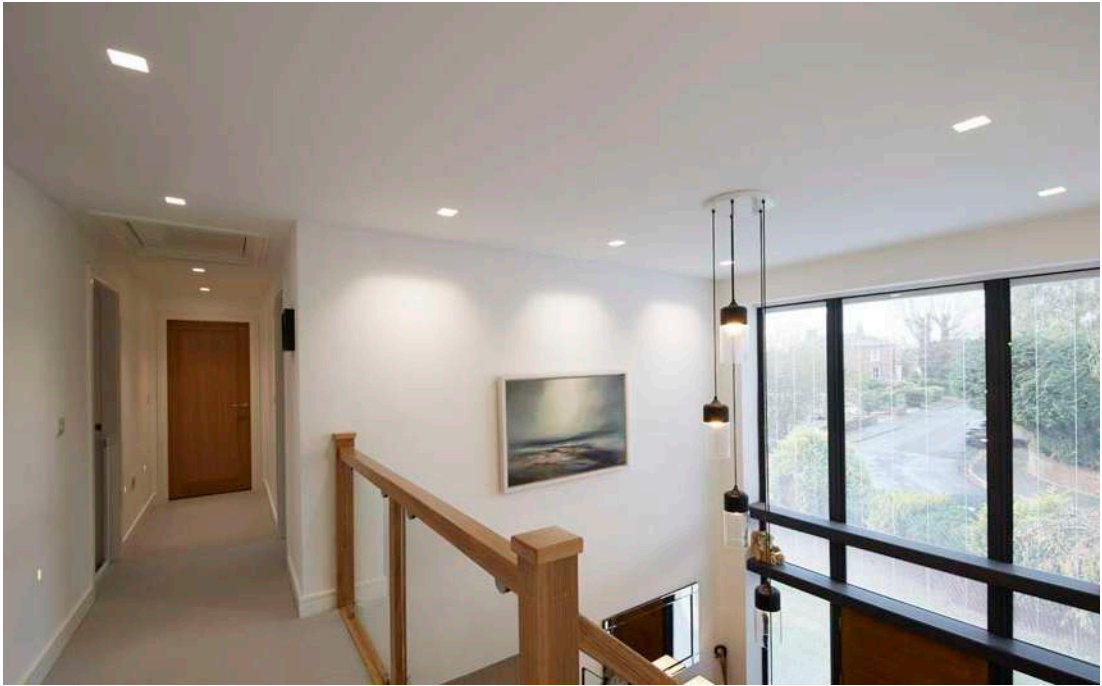

PL-REN1



PL-REN1

renne

PL-REN1 

CUT OUT
120x120mm

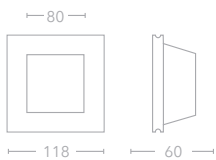

 This symbol represents a white plaster finish



CLASS 1



DIMMABLE



PAINTABLE

Key Features

White plaster

GU10 Class 1 earthed lampholder

LED only

Anti-glare

How to fit guide - See website

Ceiling must be skimmed
before fitting the item



renne twin

PL-REN2

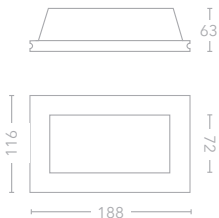

renne wall washer

PL-RENWW

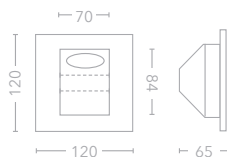

CLASS 1



DIMMABLE



PAINTABLE

Key Features

White plaster

GU10 Class 1 earthed lampholder

LED only

Anti-glare

How to fit guide - See website

Ceiling must be skimmed
before fitting the item



PL-PYREN



PL-PYREN

pyrenees plaster

Item no.	Finish	Power	CCT	Lumens	Dimmable	Replaceable LED module
PL-PYREN	<input type="checkbox"/> White plaster	350mA	3000K	60	Dimmable*	MOD1W
PL-PYREN27	<input type="checkbox"/> White plaster	350mA	2700K	60	Dimmable*	MOD1W2700

simplon plaster

Item no.	Finish	Power	CCT	Lumens	Dimmable	Replaceable LED module
PL-SIMPL	<input type="checkbox"/> White plaster	350mA	3000K	60	Dimmable*	MOD1W
PL-SIMPL27	<input type="checkbox"/> White plaster	350mA	2700K	60	Dimmable*	MOD1W2700

* Dimmable when used with a dimmable driver

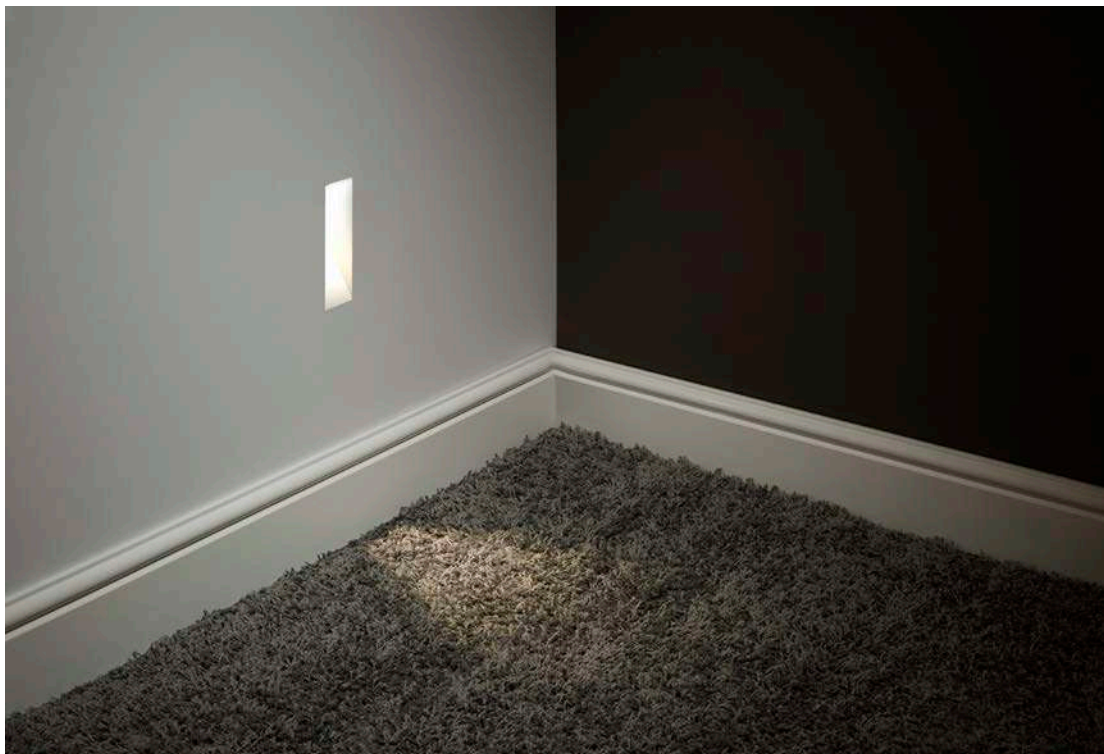

PL-SIMPL



PL-SIMPL

pyrenees plaster

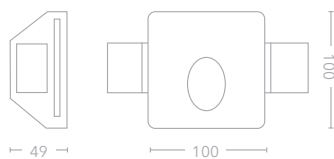

simplon plaster

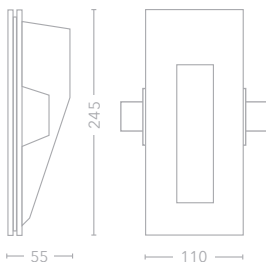

Key Features

White plaster finish

1W CREE XPE LED / 3000K

350mA Operating current

Driver supplied separately

Fittings must be wired in series

Not suitable for use in solid walls

How to fit guide - See website

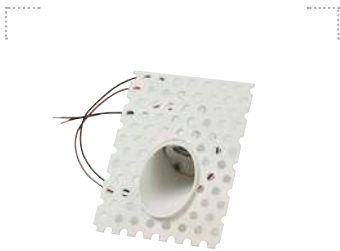
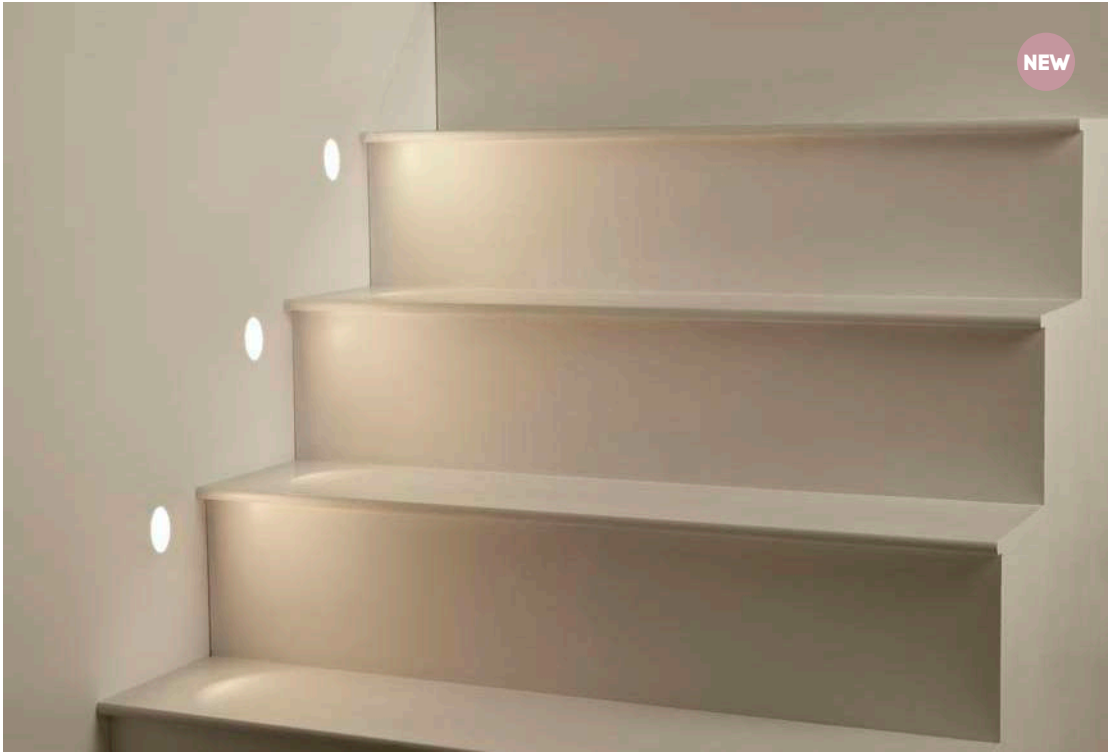

Walls must be skimmed before fitting the item

NEW





PL-BOU

boulogne LED

Item no.	Finish	Power	CCT	Lumens	Dimmable	Replaceable LED module
PL-BOU	<input type="checkbox"/> White plaster	350mA	3000K 	60	Dimmable*	MOD1W
PL-BOU27	<input type="checkbox"/> White plaster	350mA	2700K 	60	Dimmable*	MOD1W2700

blanche LED

Item no.	Finish	Power	CCT	Lumens	Dimmable	Replaceable LED module
PL-BLA	<input type="checkbox"/> White plaster	350mA	3000K 	60	Dimmable*	MOD1W
PL-BLA27	<input type="checkbox"/> White plaster	350mA	2700K 	60	Dimmable*	MOD1W2700

* Dimmable when used with a dimmable driver

NEW

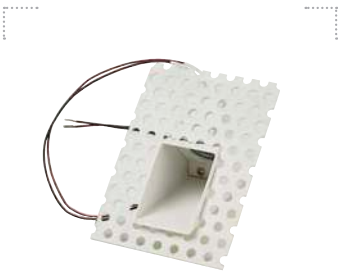
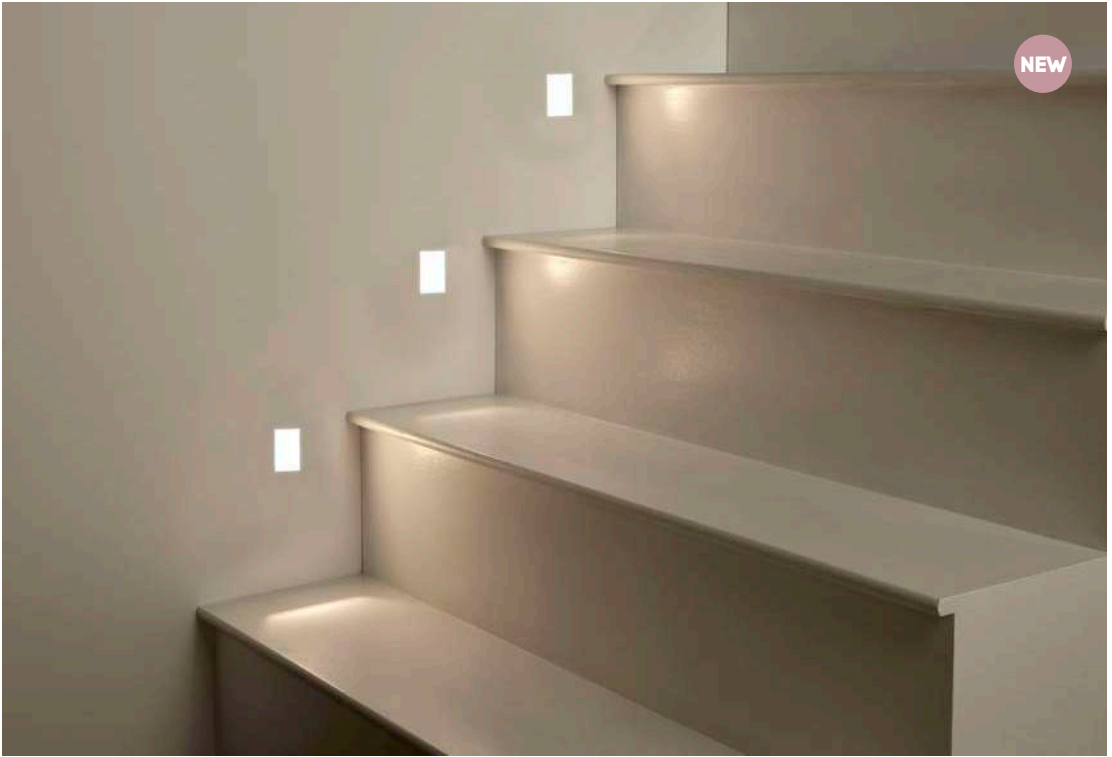

PL-BLA

**boulogne
LED**

NEW

**blanche
LED**

NEW



Key Features

Painted white finish

1W CREE XPE LED / 3000K

350mA Operating current

60 lumens

Driver supplied separately

Fittings must be wired in series

Walls must be skimmed after fitting the item

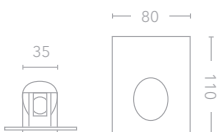



NEW



PL-BLAGU10

**blanche
GU10**

PL-BLAGU10

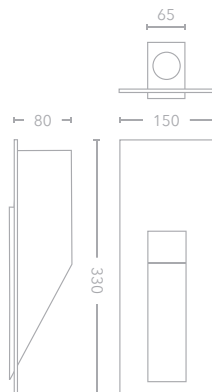

NEW



CLASS 2



DIMMABLE

Key Features

Painted white finish

GU10 LED only, max. 10W

Suitable for use in solid walls

Walls must be skimmed
after fitting the item

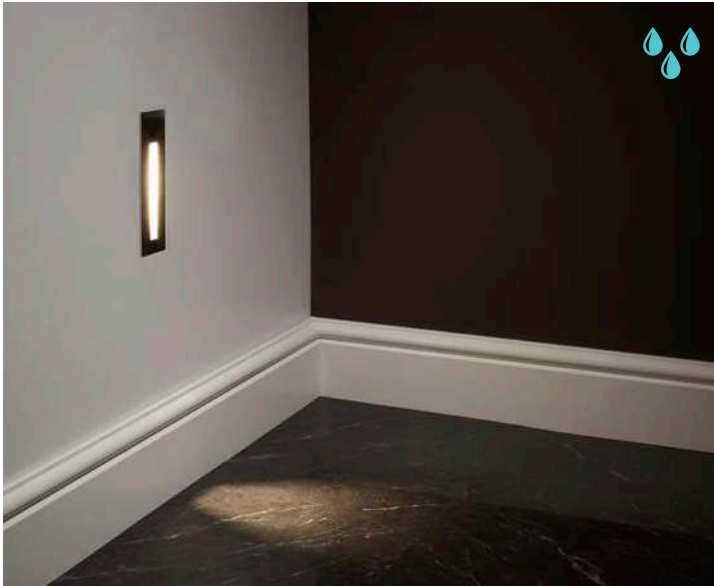

recessed / wall

IPR-WSLW

Item no.	Finish	Power	CCT	Lumens	IP Rating	Dimmable	Replaceable LED module	Class
IPR-WSLW	White	350mA	3000K	95	65	Yes*	MOD1WIP	III
IPR-WSLW-AC	White	220 - 240V**	3000K	95	65	No	MOD1WIP230V	I
IPR-WSLW27	White	350mA	2700K	95	65	Yes*	MOD1WIP-2700	III
IPR-WSLW27-AC	White	220 - 240V**	2700K	95	65	No	MOD1WIP230V-2700	I
IPR-WSLCP	Polished chrome	350mA	3000K	95	65	Yes*	MOD1WIP	III
IPR-WSLCP-AC	Polished chrome	220 - 240V**	3000K	95	65	No	MOD1WIP230V	I
IPR-WSLW27	Polished chrome	350mA	2700K	95	65	Yes*	MOD1WIP-2700	III
IPR-WSLCP27-AC	Polished chrome	220 - 240V**	2700K	95	65	No	MOD1WIP230V-2700	I
IPR-WLSLN	Satin nickel	350mA	3000K	95	65	Yes*	MOD1WIP	III
IPR-WLSLN-AC	Satin nickel	220 - 240V**	3000K	95	65	No	MOD1WIP230V	I
IPR-WLSLN27	Satin nickel	350mA	2700K	95	65	Yes*	MOD1WIP-2700	III
IPR-WLSLN27-AC	Satin nickel	220 - 240V**	2700K	95	65	No	MOD1WIP230V-2700	I

*Dimmable when used with dimmable driver **Integrated driver

simplon IP65

CUT OUT
40x147mm

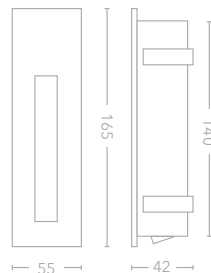

Key Features

- Aluminium body
- 1W CREE XPE LED
- Bathroom zones 1 & 2
- Wall mounted
- 350mA items require a separate driver
- Not suitable for use in solid walls



IPR-WVOW



IPR-WVOSN

Item no.	Finish	Power	CCT	Lumens	IP Rating	Dimmable	Replaceable LED module	Class
IPR-WVOW	White	350mA	3000K	95	65	Yes*	MOD1WIP	III
IPR-WVOW-AC	White	220 - 240V**	3000K	95	65	No	MOD1WIP230V	I
IPR-WVOW27	White	350mA	2700K	95	65	Yes*	MOD1WIP-2700	III
IPR-WVOW27-AC	White	220 - 240V**	2700K	95	65	No	MOD1WIP230V-2700	I
IPR-WVOSN	Satin nickel	350mA	3000K	95	65	Yes*	MOD1WIP	III
IPR-WVOSN-AC	Satin nickel	220 - 240V**	3000K	95	65	No	MOD1WIP230V	I
IPR-WVOSN27	Satin nickel	350mA	2700K	95	65	Yes*	MOD1WIP-2700	III
IPR-WVOSN27-AC	Satin nickel	220 - 240V**	2700K	95	65	No	MOD1WIP230V-2700	I

*Dimmable when used with dimmable driver **Integrated driver

vosges IP65

*can be used in solid walls



CUT OUT
60mm

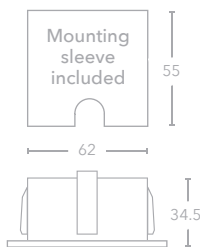
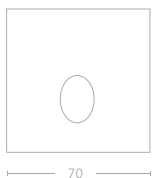

Key Features

Aluminium body

1W CREE XPE LED

Bathroom zones 1 & 2

Wall mounted

350mA items require a separate driver

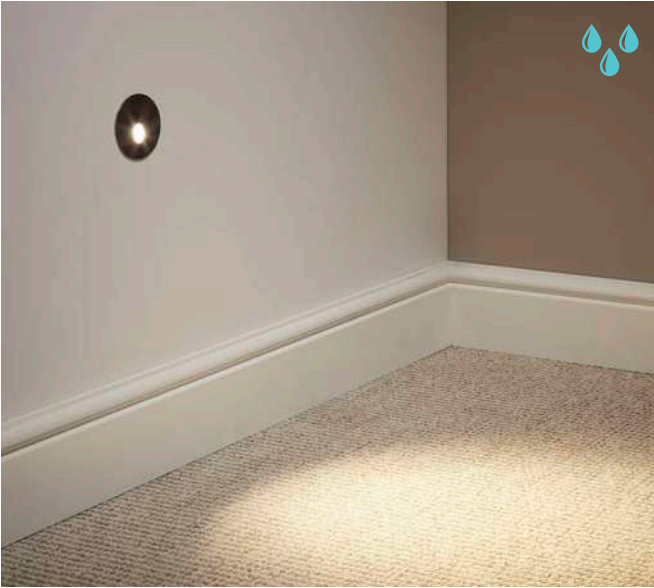

IPR-WRW

Item no.	Finish	Power	CCT	Lumens	IP Rating	Dimmable	Replaceable LED module	Class
IPR-WRW	White	350mA	3000K	95	65	Yes*	MOD1WIP	III
IPR-WRW-AC	White	220 - 240V**	3000K	95	65	No	MOD1WIP230V	I
IPR-WRW27	White	350mA	2700K	95	65	Yes*	MOD1WIP-2700	III
IPR-WRW27-AC	White	220 - 240V**	2700K	95	65	No	MOD1WIP230V-2700	I
IPR-WRCP	Polished chrome	350mA	3000K	95	65	Yes*	MOD1WIP	III
IPR-WRCP-AC	Polished chrome	220 - 240V**	3000K	95	65	No	MOD1WIP230V	I
IPR-WRW27	Polished chrome	350mA	2700K	95	65	Yes*	MOD1WIP-2700	III
IPR-WRCP27-AC	Polished chrome	220 - 240V**	2700K	95	65	No	MOD1WIP230V-2700	I
IPR-WRSN	Satin nickel	350mA	3000K	95	65	Yes*	MOD1WIP	III
IPR-WRSN-AC	Satin nickel	220 - 240V**	3000K	95	65	No	MOD1WIP230V	I
IPR-WRSN27	Satin nickel	350mA	2700K	95	65	Yes*	MOD1WIP-2700	III
IPR-WRSN27-AC	Satin nickel	220 - 240V**	2700K	95	65	No	MOD1WIP230V-2700	I

*Dimmable when used with dimmable driver **Integrated driver

pyrenees IP65

*can be used in solid walls



CUT OUT
60mm

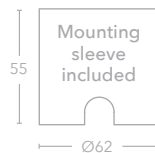
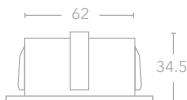
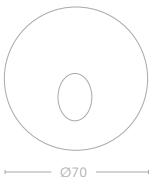

Key Features

Aluminium body

1W CREE XPE LED

Bathroom zones 1 & 2

Wall mounted

350mA items require a separate driver



holborn round IP65

IPR-HOLCP

IPR-HOLSS

hoxton square IP65

IPR-HOXCP

IPR-HOXSS

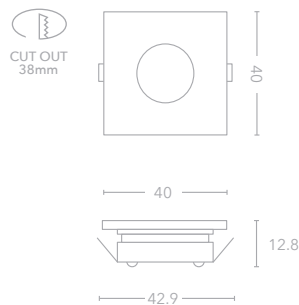
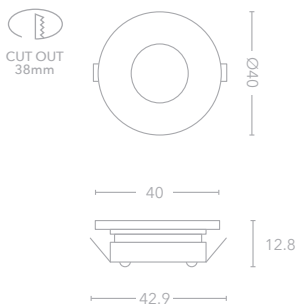

Key Features

Polished chrome or satin stainless steel 316 / Aluminium body

1W CREE XPE / 3000K

Operating current: 350mA

90 lumens / Beam angle: 120°

Very shallow profile

Bathroom zones 1 & 2

Driver supplied separately

Fittings must be wired in series

holborn anti glare IP65

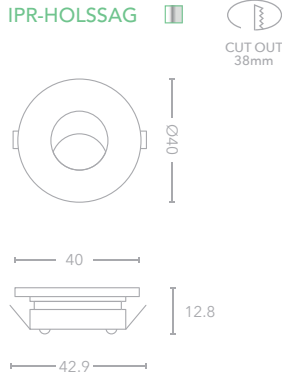

Key Features

Satin stainless steel 316

1W CREE XPE / 3000K

25 lumens / Beam angle: 120°

Very shallow profile

Bathroom zones 1 & 2

Driver supplied separately

Fittings must be wired in series

ankle light

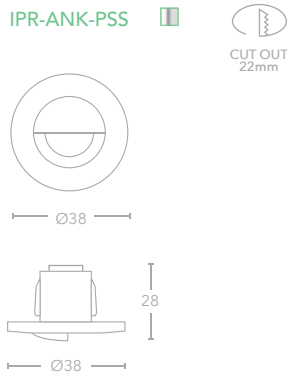

Key Features

316L Mirror polished stainless steel body

1.2W LED / 3000K

95 lumens / Beam angle 120°

Bathroom zones 1 & 2

Driver supplied separately

Fittings must be wired in series

diana

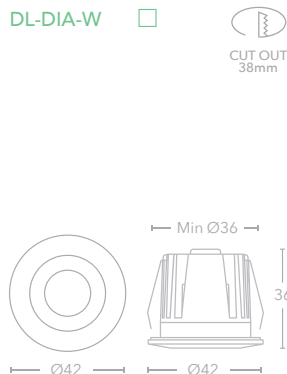

Key Features

Sand white finish / Die cast body

1.1W Olsen LED / 3000K

95 lumens / Beam angle 30°

Bathroom zone 2

Driver supplied separately

Fittings must be wired in series



track & spot





NEW

NEW



TR-APO-W

TR-APO-B

apollo GU10 track spot

NEW

- TR-APO-B ■
- TR-APO-W □

 CLASS 2
  SWITCH
  DIMMABLE

Key Features

- Steel / Sand white or Sand black head
- GU10 LED only / Max. 10W
- Track mounted head
- 350° Rotation / 90° Tilt
- 58mm max lamp length
- On/Off switch on track connector

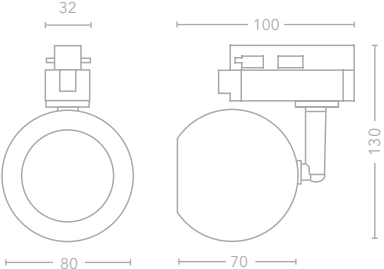



TR-PEG-W

TR-PEG-B

pegasus GU10 track spot

- TR-PEG-B ■
- TR-PEG-W □

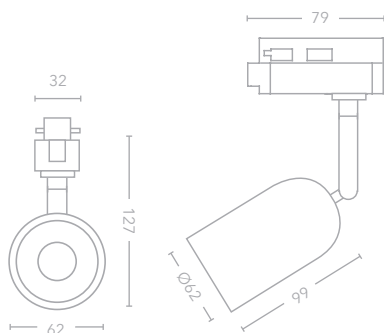

-  CLASS 1
-  SWITCH
-  DIMMABLE

Key Features

- Steel / Sand white or Sand black head
- GU10 LED only / Max. 10W
- Track mounted head
- 350° Rotation / 90° Tilt
- 58mm max lamp length
- On/Off switch on track connector



NEW

NEW



TR-AND-W



TR-AND-B



TR-LIB-WW

andromeda track spot

- TR-AND-B ■
- TR-AND-W □

NEW



CLASS 2



SWITCH



DIMMABLE

Key Features

- Die cast construction / Sand white or Sand black head
- GU10 LED only / Max. 10W
- Track mounted head
- 350° Rotation / 90° Tilt
- On/Off switch on track connector

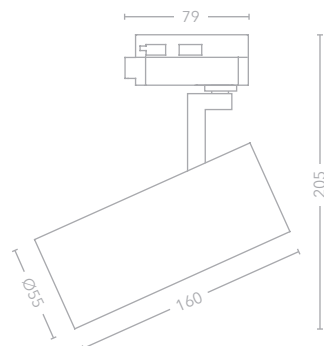



TR-LIB-B

TR-ORI-W

TR-ORI-B

libra GU10 track spot

- TR-LIB-B ■
- TR-LIB-WW □

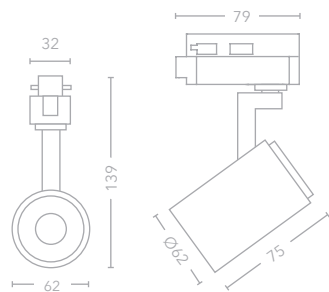

orion track spot

NEW

- TR-ORI-B ■
- TR-ORI-W □

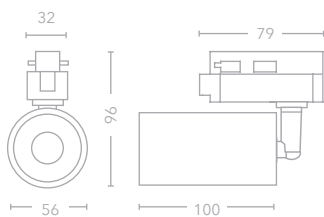

- CLASS 2
- SWITCH
- DIMMABLE

Key Features

- Die cast construction / Sand white or Sand black head
- GU10 LED only / Max. 10W
- Track mounted head
- 350° Rotation / 90° Tilt
- 58mm max lamp length
- On/Off switch on track connector



TR-GEM-W



TR-GEM-B

gemiini 13w LED track spot

TR-GEM-B ■
 TR-GEM-W □
 1280 lumens

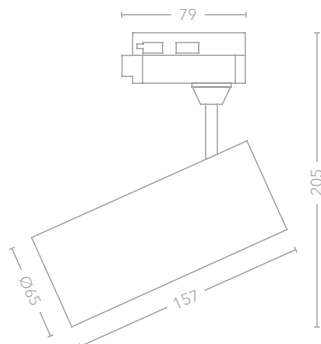

CLASS 1



SWITCH



DIMMABLE

Key Features

Die cast construction / Sand white with Silver ring and interchangeable White ring / Sand black with Gold ring and interchangeable Black ring
 13W COB LED / TRIAC dimmable
 36° Beam angle
 350° Rotation / 90° Tilt
 On/Off switch on track connector

NEW

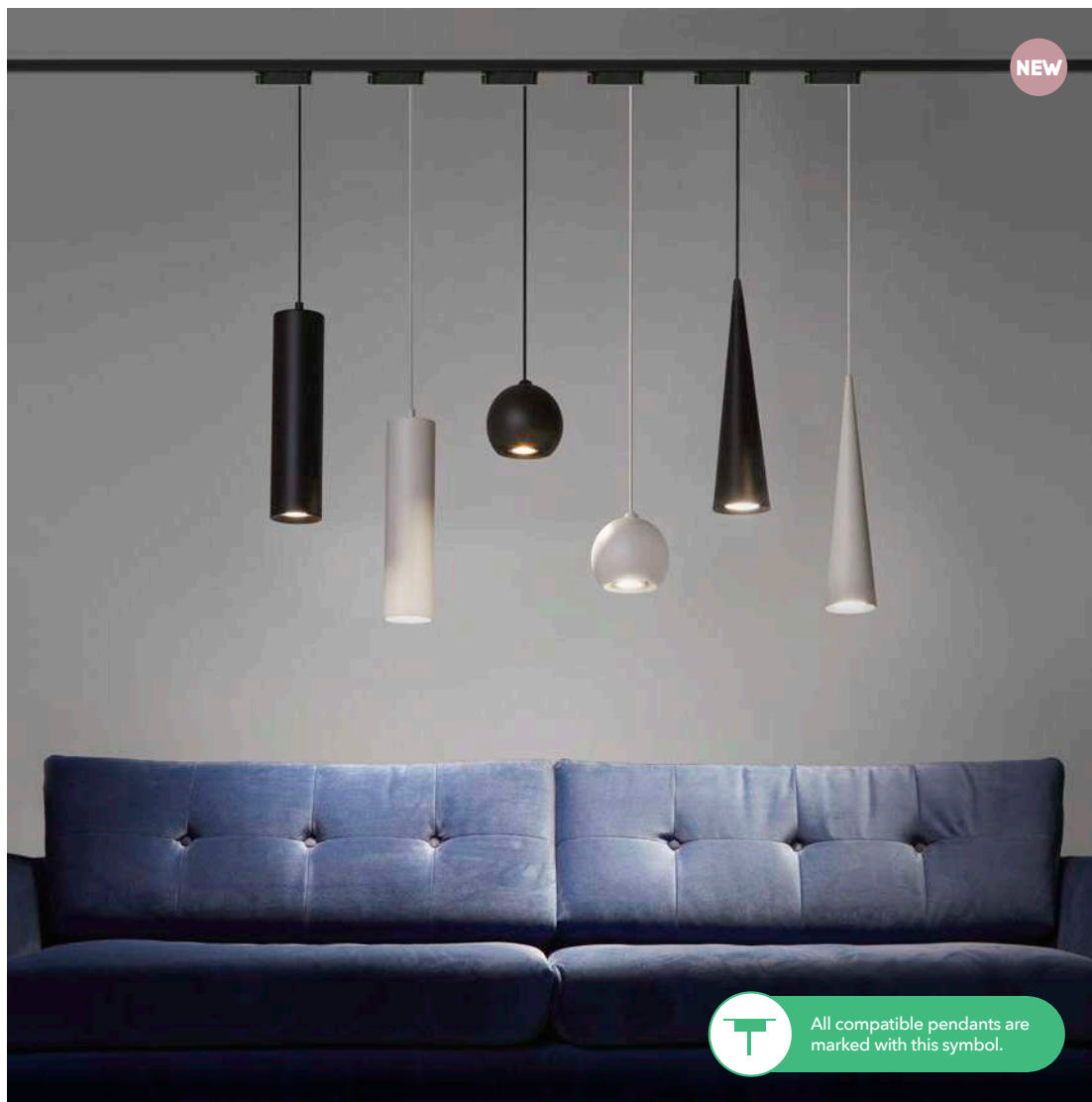

All compatible pendants are marked with this symbol.

pendant track adapter

NEW

TR-PEN-B ■
TR-PEN-W □

Use with any 220-240V pendant under 2kg that is suspended by a single power cable.



CLASS 1



DIMMABLE



240 VOLTS

Key Features

Used to convert mains voltage pendants meeting the following criteria:

1. Suspended by a single power cable
2. Maximum 2kg weight



All compatible pendants are marked with this symbol



TR-1W / TR-1B

1m track kit

TR-1B

TR-1W

Includes live end & end cap
L1000 x W35 x H18mm

1m track only

TR-T1-B

TR-T1-W

L1000 x W35 x H18mm

2m track kit

TR-2B

TR-2W

Includes live end & end cap
L2000 x W35 x H18mm

2m track only

TR-T2-B

TR-T2-W

L2000 x W35 x H18mm



CLASS 1



DIMMABLE



240 VOLTS

Key Features

Extensive range of track
& connectors

Ideal for applications where fittings
need to be moved or added

Track can be cut to any length

Earth on the neutral side



TR-EC-W



TR-LE-W



TR-MJ-W

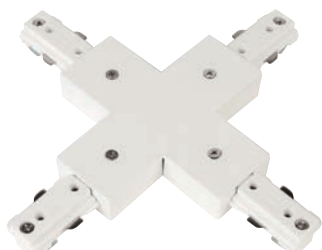

TR-XC-W



TR-LC-W

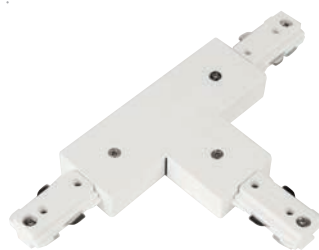

TR-TC-W



TR-SUS-W



TR-CC-W



TR-CC-B
All options available in Black

end cap

TR-EC-B

TR-EC-W

L18 x W35 x H18mm

live end

TR-LE-B

TR-LE-W

L108 x W35 x H18mm

mini joiner

TR-MJ-B

TR-MJ-W

L80 x W35 x H18mm

X connector

TR-XC-B

TR-XC-W

L182 x W182 x H18mm

L connector

TR-LC-B

TR-LC-W

L108 x W108 x H18mm

T connector

TR-TC-B

TR-TC-W

L182 x W108 x H18mm

3m suspension kit

TR-SUS-B

TR-SUS-W

centre connector

TR-CC-B With power feed in

TR-CC-W L180 x W35 x H18mm



CLASS 1



DIMMABLE



240 VOLTS

Key Features

Extensive range of track & connectors

Ideal for applications where fittings need to be moved or added

Earth on the neutral side

Suspension kit length is adjustable

NEW





moon 1

NEW

moon 1 round

moon recessed

NEW

- SP-MOO1-B ■
- SP-MOO1-W □
- SP-MOO1S-B* ■
- SP-MOO1S-W* □

- SP-MOO1R-B ■
- SP-MOO1R-W □
- 1 x GU10 LED
- Class I

- SP-MOOR-B ■
- SP-MOOR-W □
- 1 x GU10 LED
- Class II



1 x GU10 LED

Class I

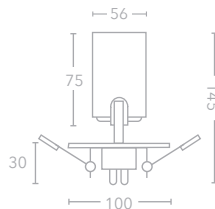
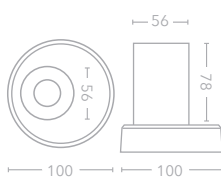
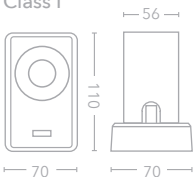

DIMMABLE

Key Features

Sand white or Sand black /
Die cast construction

GU10 LED only / Max. 10W each

Ceiling / Wall mounted

350° Rotation

90° Pivot

58mm max lamp length

Cut out for SP-MOOR 60-85mm

* Switched



SP-MOO3-B



SP-MOO3-W



SP-MOO3L-W



SP-MOO3L-B

moon 3

SP-MOO3-B ■
 SP-MOO3-W □
 3 x GU10 LED

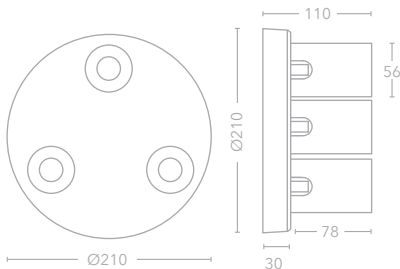

moon 3 bar

SP-MOO3L-B ■
 SP-MOO3L-W □
 3 x GU10 LED

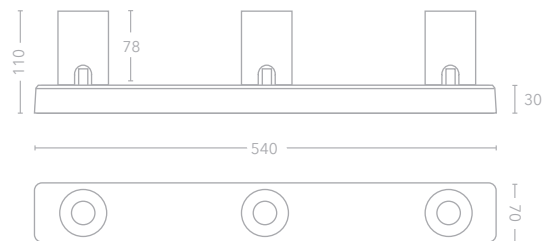

NEW



SP-MOO3L-B / SP-MOO4-B

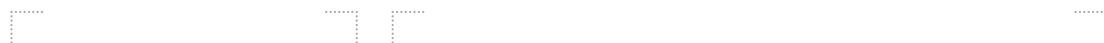

SP-MOO2-W



SP-MOO4-W

moon 4 bar

- SP-MOO4-B ■
- SP-MOO4-W □
- 4 x GU10 LED

moon 2 bar

- SP-MOO2-B ■
- SP-MOO2-W □
- 2 x GU10 LED

NEW

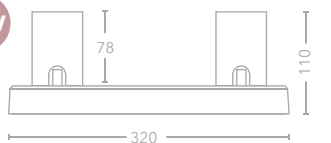

CLASS 1



DIMMABLE

Key Features

Sand white or Sand black /
Die cast construction

GU10 LED only / Max. 10W each

Ceiling / Wall mounted

350° Rotation

90° Pivot

58mm max lamp length

NEW



SP-SEL3R-W



SP-SEL3R-B

selene 3 round

SP-SEL3R-B ■

SP-SEL3R-W □

3 x GU10 LED

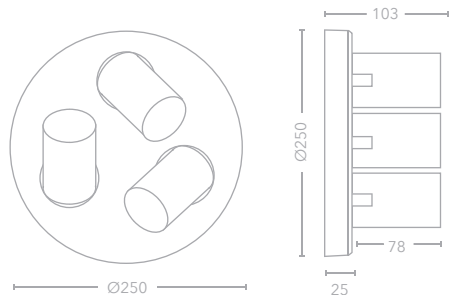

NEW



CLASS 2



DIMMABLE



IP44



GLASS

Key Features

Sand white or Sand black /
Die cast construction

GU10 LED only / Max. 10W each

Ceiling / Wall mounted

350° Rotation

90° Pivot

58mm max lamp length

NEW



SP-SEL3L-B



SP-SEL3L-W

selene 3 long

SP-SEL3L-B ■

SP-SEL3L-W □

3 x GU10 LED

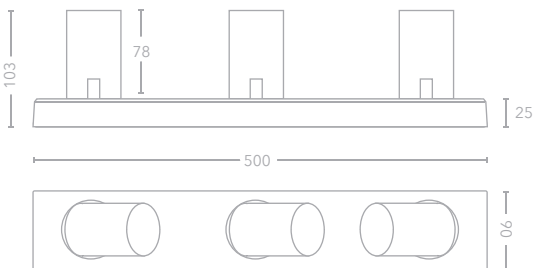

NEW



CLASS 2



DIMMABLE



IP 44



GLASS

Key Features

Sand white or Sand black /
Die cast construction

GU10 LED only / Max. 10W each

Ceiling / Wall mounted

350° Rotation

90° Pivot

58mm max lamp length

NEW



SP-APO3-W



SP-APO1-W

apollo 3

- SP-APO3-B ■
- SP-APO3-W □
- 3 x GU10 LED
- Class I

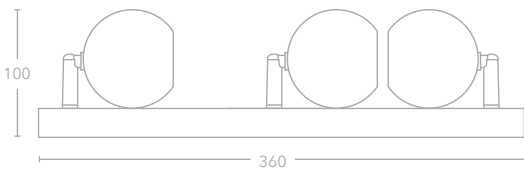
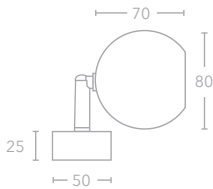

NEW

apollo 2

- SP-APO2-B ■
- SP-APO2-W □
- 2 x GU10 LED
- Class I

NEW

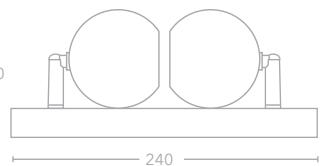
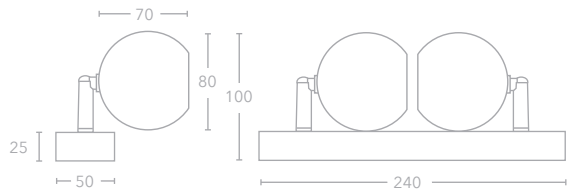



SP-APO2-W



SP-APOR-B



SP-APO2-B



SP-APOR-W

apollo 1

NEW

- SP-APO1-B ■
- SP-APO1-W □
- 1 x GU10 LED
- Class I

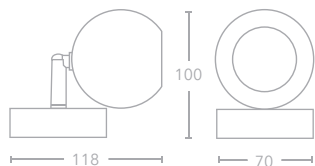

apollo recessed

NEW

- SP-APOR-B ■
- SP-APOR-W □
- 1 x GU10 LED
- Class II

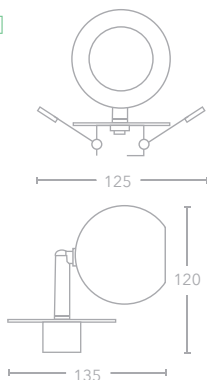

DIMMABLE

Key Features

Steel / Sand white or
Sand black

GU10 LED / Max. 10W

Ceiling / Wall mounted

350° Rotation

90° Pivot

58mm max lamp length

Cut out for SP-APOR 60-85mm

NEW





SP-JUP1-W



SP-JUP2-B



SP-JUP1-B



SP-JUP2-W

jupiter 1

NEW

SP-JUP1--B ■
 SP-JUP1-W □
 1 x ES111

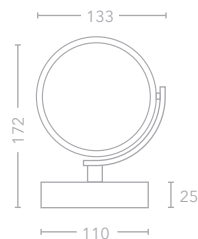

jupiter 2

NEW

SP-JUP2-B ■
 SP-JUP2-W □
 2 x ES111

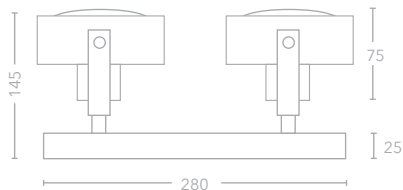

CLASS 1



DIMMABLE

Key Features

Steel / Sand white or
 Sand black

ES111 Max. 75W

Ceiling / Wall mounted

350° Rotation

120° Pivot



led strip

guide to using LED strip

① choose your strip and connectors

- 4.8W/m - feature glow of light
- 14.4W/m - ambient light

② choose your colour temperature

- Cool White is 4000K ●
- Warm White is 3000K ●

③ choose your profile

- Recessed profiles conceal lines of light
- Surface mounted profiles are easy to fit
- Use corner profile for angling the strip at 45° to a surface, particularly useful for lighting shelves, inside wardrobes and over kitchen worktops
- A profile must be used with 14.4W/m strips

④ select your driver

- Multiply the total number of metres of strip to be run from a single driver by the wattage of the strip and then add 10% e.g. 16m of 4.8W/m strip plus 10% = 85W
- Decide if your circuit needs to be dimmable
- Select the driver e.g. dimmable LST-DRD80, non-dimmable LST-DR100



LST-4-3-IP / LST-4-3



LST-CON3



LST-CON4

Driver:
Supplied separately
See page 68-69



4.8w/m LED strip IP65



73 lumens per Watt

LST-4-3-IP ● 3000K

LST-4-4-IP ● 4000K

4.8w/m LED strip

83 lumens per Watt

LST-4-3 ● 3000K

LST-4-4 ● 4000K



CLASS 3



DIMMABLE



24 VOLTS

Key Features

5 metre roll

CRI Ra>80

3528 Epistar SMD LED

2oz double sided PCB for
longer strip runs

Power feed-in required every 10m

Cut distance every 100mm

Supplied with 150mm tails
on both ends



8mm inline connector

LST-CON3



8mm corner connector / power feed in

LST-CON4
2 x Wire





LST-14-3-IP / LST-14-3



LST-CON1



LST-CON2

Driver:
Supplied separately
See page 68-69



14.4w/m LED strip IP65



90 lumens per Watt

LST-14-3-IP ● 3000K
LST-14-4-IP ● 4000K

14.4w/m LED strip

100 lumens per Watt

LST-14-3 ● 3000K
LST-14-4 ● 4000K



CLASS 3



DIMMABLE



24 VOLTS

Key Features

5 metre roll

CRI Ra>80 / 24V / 3000K

2835 Epistar SMD LED

2oz double sided PCB for
longer strip runs

Power feed-in required every 10m

Cut distance every 100mm

Supplied with 150mm tails
on both ends

Aluminium profile must be used



10mm inline connector

LST-CON1



15

10mm corner connector / power feed in

LST-CON2

2 x Wire



15

160



LST-PRO-PL1



LST-PRO-R1



LST-PRO-HS



LST-PRO-PL1

recessed aluminium profile

LST-PRO-R1

L1000 x W25 x H16mm

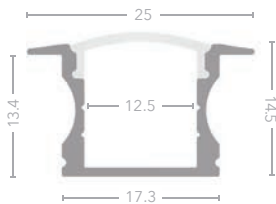

aluminium heat sink

LST-PRO-HS

L1000 x W25 x H8mm

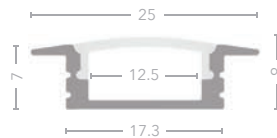

plastered in profile

LST-PRO-PL1

L1000 x W55.5 x H15mm

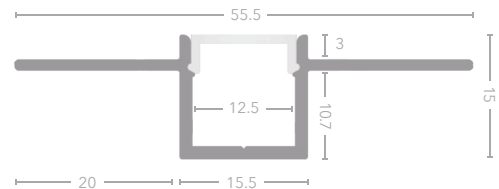



LST-PRO-SM1



LST-PRO-COR

surface mounted aluminium profile

LST-PRO-SM1

L1000 x W17.2 x H15mm

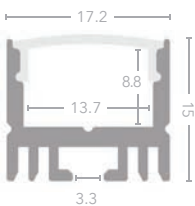

45° corner profile

LST-PRO-COR

L1000 x W18.1 x H18.1mm

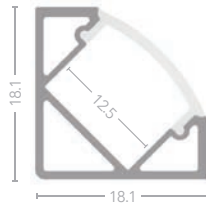

Key Features

Aluminium / Opal PC diffuser

Includes 2 x End caps

2 x Installation clips with surface profile



LST-DRD200



LST-DRD150



LST-DRD120



LST-DRD80

LED drivers - dimmable

INPUT POWER
+/-220-250V

MAINS
DIMMER

DIMMING
SYSTEM

MAINS
DIM DRIVER



LED STRIP

LED STRIP

TRIAC dimmable 24v 200w driver

LST-DRD200

TRIAC dimmable 24v 150w driver

LST-DRD150

TRIAC dimmable 24v 120w driver

LST-DRD120

TRIAC dimmable 24v 80w driver

LST-DRD80



IP
66



DIMMABLE



24 VOLTS

Key Features

PWM Output

Loading: 1-100%

Short circuit protection

TRIAC Dimmable

Dimming range: 0-100%

Leading and trailing edge

Lutron & Clipsal C-BUS compatible



LST-DR150



LST-DR100



LST-DR75



LST-DR50



LST-DR20

LED drivers - non dimmable

INPUT POWER
+/-220-250V

ON/OFF



LED STRIP

**LED 24v
150w driver**

LST-DR150

**LED 24v
100w driver**

LST-DR100

**LED 24v
75w driver**

LST-DR75

**LED 24v
50w driver**

LST-DR50

**LED 24v
20w driver**

LST-DR20



CLASS 2



24 VOLTS

Key Features

Loading: 1-100%

Over load, short circuit and thermal protection





ceiling



ara pendant 100

PE-ARA100-B ■

PE-ARA100-W □

60W SMD LED

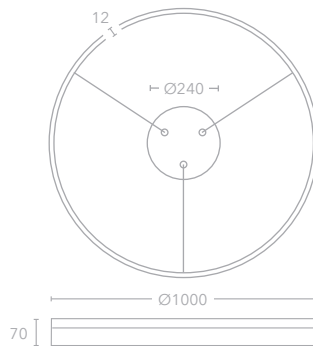
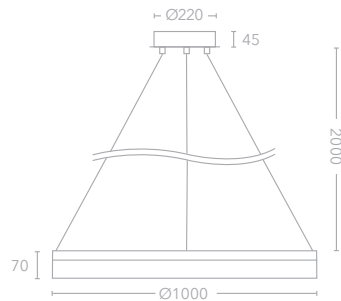

NEW



CLASS 1



DIMMABLE



Key Features

Sand white or Black body /
Frosted acrylic diffuser

3000K / 4000K switchable

Switch in ceiling can

Mains dimmable

Power factor 0.95 / CRI >80

5600 lumens at 4000K

5400 lumens at 3000K



PE-ARA60-W



PE-ARA60-W



PE-ARA100-B



ara pendant 60

PE-ARA60-B ■

PE-ARA60-W □

30W SMD LED

NEW



CLASS 1



DIMMABLE



Key Features

Sand white or Black body /
Frosted acrylic diffuser

3000K / 4000K switchable

Switch in ceiling can

Mains dimmable

Power factor 0.95 / CRI >80

2800 lumens at 4000K

2700 lumens at 3000K

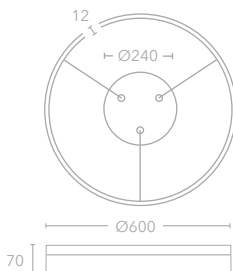
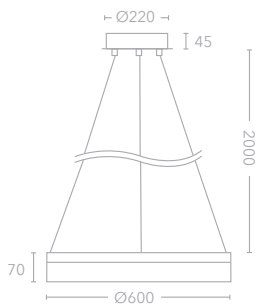



PE-COM2-B



PE-COM2-W

compass 2

PE-COM2-B ■ 6000 lumens

PE-COM2-W □ 92W SMD LED

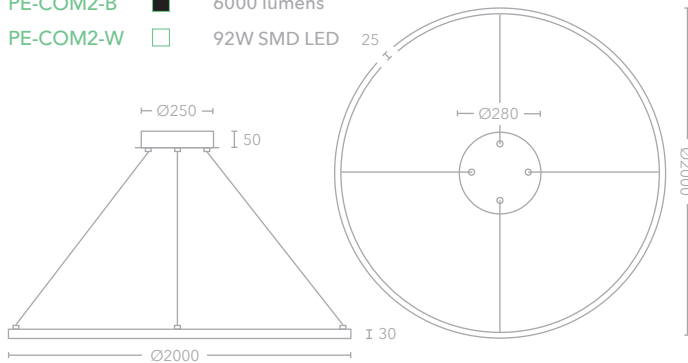

CLASS 1

Key Features

Sand black or Sand white body /
Sand white ceiling can / Die cast
aluminium / Opal acrylic diffuser

3000K / 120° / CRI > 80 / PF 0.95

Non-dimmable

Height adjustable, min. 90cm,
max. 3m drop



PE-ORB120-B

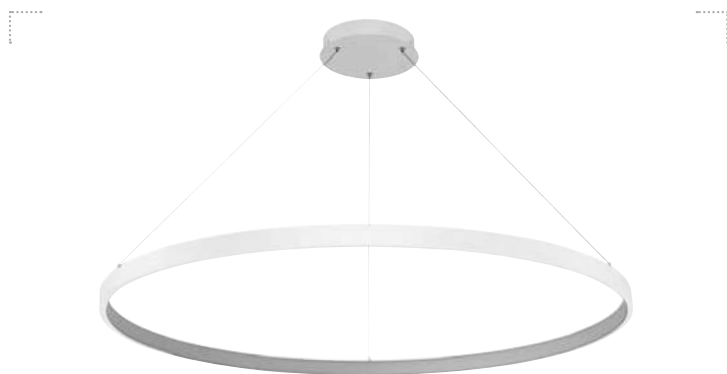

PE-ORB120-W



Illuminated inside ring

orbit 120

- PE-ORB120-B ■ 3300 lumens
 PE-ORB120-W □ 60W SMD LED

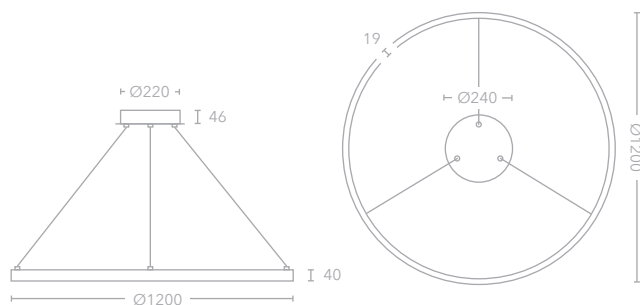

CLASS 1



DIMMABLE

Key Features

Sand black or Sand white body /
 Sand white ceiling can / Die cast
 aluminium / Opal silicone diffuser

3000K / 120° / CRI > 80 / PF 0.95

Mains dimmable

Height adjustable, min. 60cm,
 max. 2m drop



PE-ETE78-B

eternity 78 pendant

PE-ETE78 PE-ETE78-B
 80W SMD LED 80W SMD LED
 4700 lumens 3900 lumens

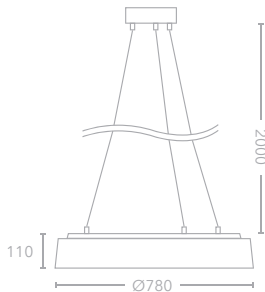

PE-ETE78



CLASS 1



DIMMABLE

Key Features

Sand white or Black body / Sand white ceiling can / Opal PC diffuser

3000K

Beam Angle: 120°

Power factor 0.95

CRI >80

Mains dimmable



PE-ETE55-B



FL-ETE55



PE-ETE55



FL-ETE55

eternity 55 pendant

PE-ETE55 PE-ETE55-B
 40W SMD LED 40W SMD LED
 3300 lumens 2400 lumens

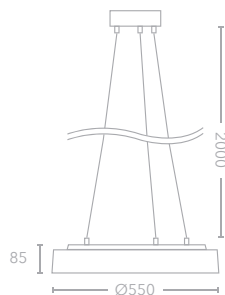

eternity 55 flush

FL-ETE55
 40W SMD LED
 2020 lumens

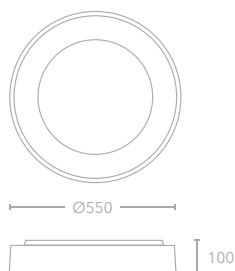

CLASS 1



DIMMABLE

Key Features

Sand white or Black body /
Opal PC diffuser

3000K

Beam Angle: 120°

Power factor 0.95

CRI >80

Mains dimmable

NEW

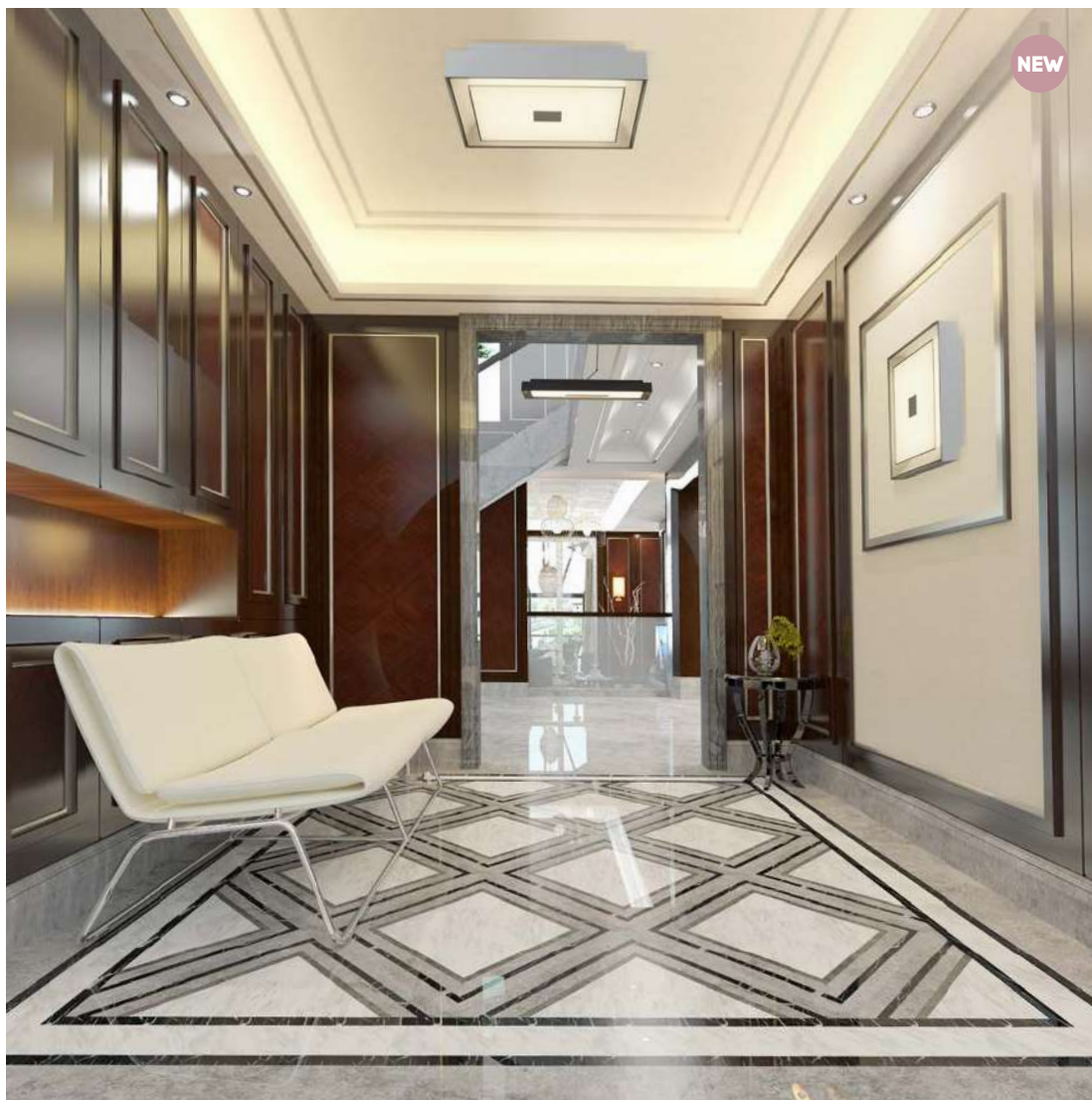

hepburn square pendant & flush

CE-HEPS43-B ■
 CE-HEPS43-W □
 25W SMD LED
 1400 lumens

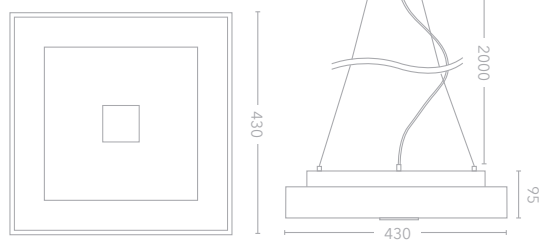

NEW

hepburn round pendant & flush

CE-HEPR40-B ■
 CE-HEPR40-W □
 25W SMD LED
 1300 lumens

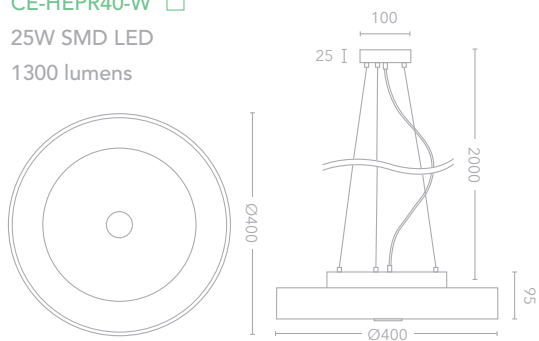

NEW

NEW

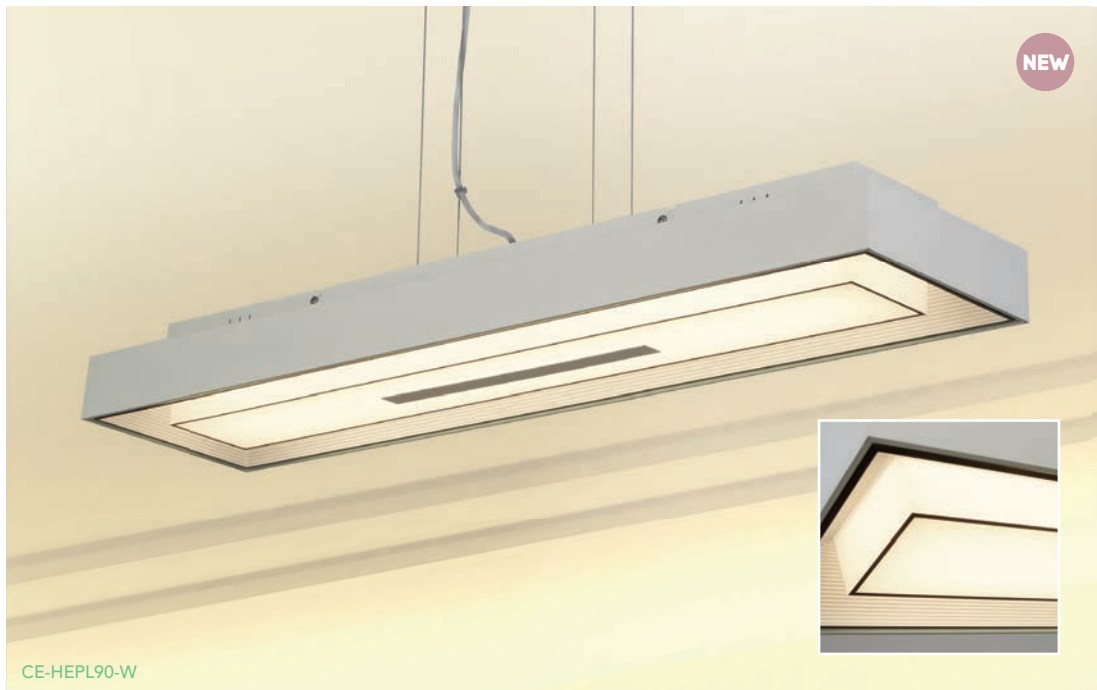

CE-HEPL90-W



CE-HEPS43-W



CE-HEPR40-B

hepburn long pendant & flush

- CE-HEPL90-B ■
- CE-HEPL90-W □
- 25W SMD LED
- 1300 lumens

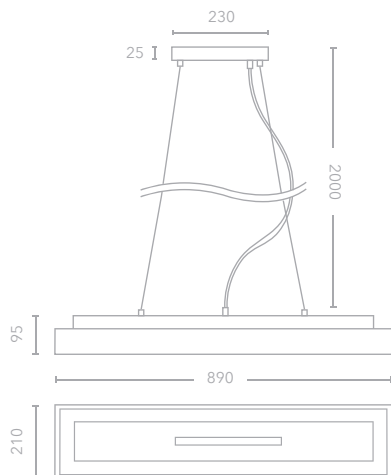

NEW



CLASS 1



DIMMABLE



GLASS

Key Features

Sand white / Sand black
Steel and glass

3000K

Mains dimmable

Power factor 0.9

Supplied as a surface mounted item, with 2m pendant adapter included in the box



PE-CLIP



PE-CLIP

clip pendant

PE-CLIP
 40W SMD LED
 2630 lumens

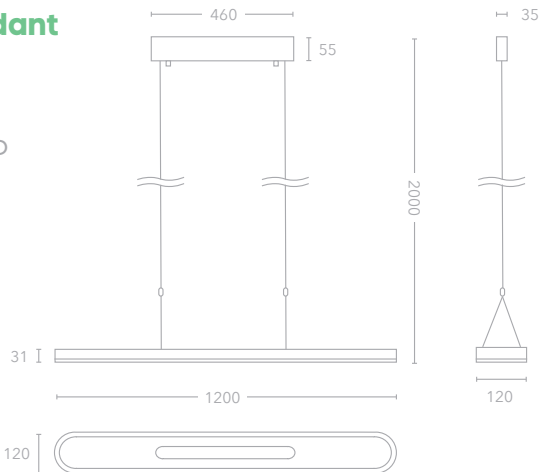

CLASS 1



DIMMABLE

Key Features

Sand white
 Frosted acrylic diffuser
 3000K
 Mains dimmable
 Height adjustable
 CRI >80
 Power factor 0.98

NEW



CE-LINO-B



10% light up from pendant

CE-LINO-W

lino pendant / flush

NEW

- CE-LINO-B ■
- CE-LINO-W □
- 30W SMD LED
- 2800 lumens

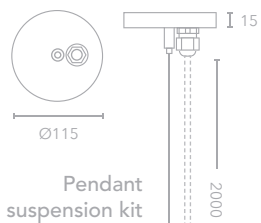

CLASS 1

Key Features

Sand white / Sand black

Opal PC diffuser

3000K

Pendant drop max 2m

CRI >80

Power factor 0.98

Flush mounting kit included in the box





athena pendant

PE-ATH-B



PE-ATH-W

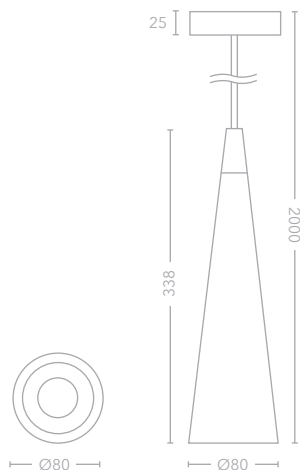

CLASS 1



DIMMABLE



TRACK
ADAPTER

Key Features

Sand white / Sand black

Steel

GU10 LED only / Max 10W

Height adjustable



Compatible with
Pendant Track Adapter



PE-ART-B

PE-ART-W



PE-APO-B

PE-APO-W



PE-ATH-B

PE-ATH-W

artemis pendant

PE-ART-B



PE-ART-W

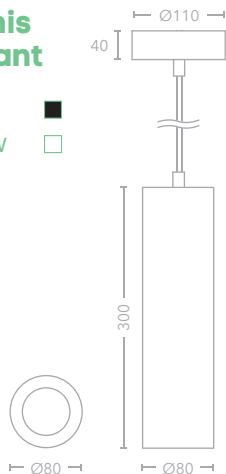

apollo pendant

PE-APO-B



PE-APO-W

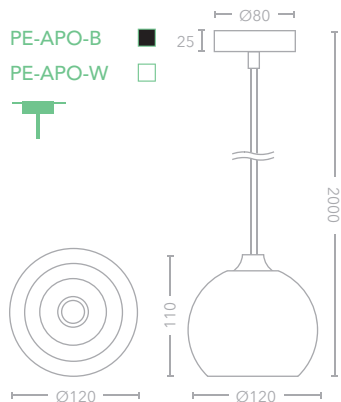

CLASS 1



DIMMABLE



TRACK ADAPTER

Key Features

Sand white / Sand black

Steel

GU10 LED only / Max 10W

Height adjustable



Compatible with
Pendant Track Adapter



CE-HONSQ2B

honos square twin

CE-HONSQ2B ■ 2 x GU10

CE-HONSQ2W □

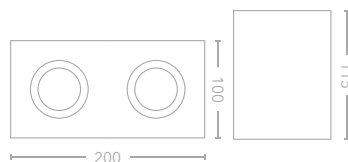



CE-HONRW



CE-AND-W



CE-HONSQW



CE-AND-B



CE-HONRB



CE-HONSQB

honos round

CE-HONRB ■
CE-HONRW □
1 x GU10

honos square

CE-HONSQB ■
CE-HONSQW □
1 x GU10

andromeda ceiling

CE-AND-B ■
CE-AND-W □
1 x GU10

TR-AND
track version
available.

NEW



DIMMABLE

Key Features

- Steel / Sand painted finish
- GU10 LED only, max. 10W each
- Anti glare

Honos

Class II / 20° Tilt, 360° Rotation

Andromeda

Class I / 90° Pivot, 350° Rotation

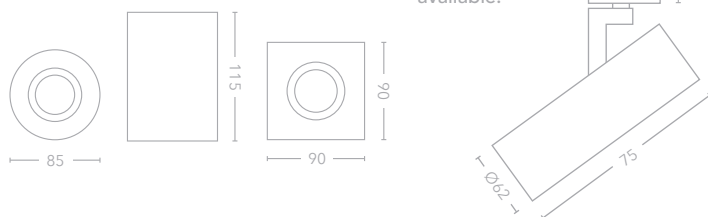

NEW

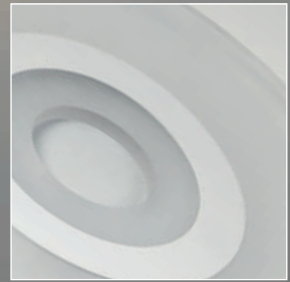

orcus

CE-ORC40-B □

23W SMD LED

1900 lumens

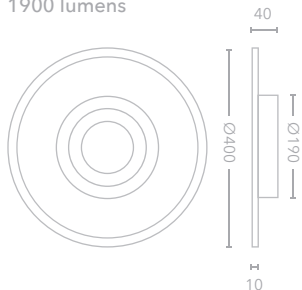

NEW



CLASS 1



DIMMABLE

Key Features

Acrylic

3000K

Mains dimmable

Power Factor 0.9

Ceiling or wall mounted

NEW



FL-SAT60-W



FL-SAT40-W



FL-SAT40-B

saturn 60

NEW

FL-SAT60-B ■ 2900 lumens
 FL-SAT60-W □ 3700 lumens
 42W SMD LED

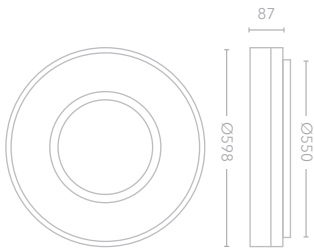

saturn 40

NEW

FL-SAT40-B ■ 1800 lumens
 FL-SAT40-W □ 2500 lumens
 30W SMD LED

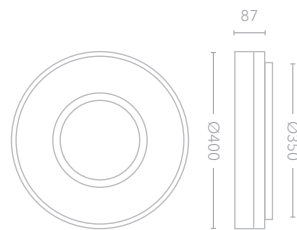

CLASS 1



DIMMABLE

Key Features

- Matt Black / Matt White
- Steel and acrylic
- 3000K
- Mains dimmable
- Power Factor 0.9
- Ceiling or wall mounted

NEW



FL-BAN35-B



FL-BAN35-B



FL-BAN23-B

banda

NEW



CLASS 2



DIMMABLE



IP
44



GLASS

FL-BAN35-B ■

23W SMD LED

650 lumens

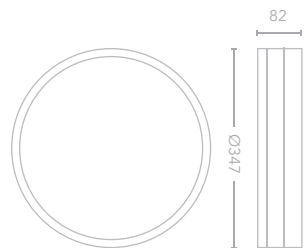

FL-BAN23-B ■

12W SMD LED

330 lumens

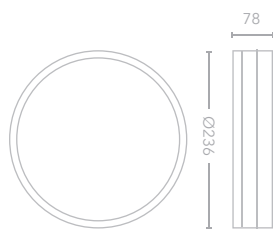

Key Features

Sand black / Matt white glass

SMD LED 3000K

Ceiling / Wall mounted

Mains dimmable

Power factor 0.9

Bathroom zone 2

NEW



FL-ADM40-W



FL-ADM40-W



FL-ADM30-W

andaman

NEW



CLASS 2



DIMMABLE



IP 44



GLASS

FL-ADM40-W

24W SMD LED

1150 lumens

FL-ADM30-W

12W SMD LED

670 lumens

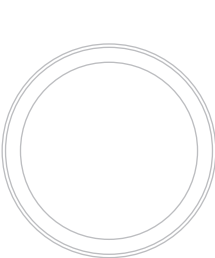

Key Features

Matt white glass /
Clear glass outer shade

SMD LED 3000K

Ceiling / Wall mounted

Mains dimmable

Power factor 0.9

Bathroom zone 2



lyra pendant

PE-LYRAW 
 PE-LYRAB

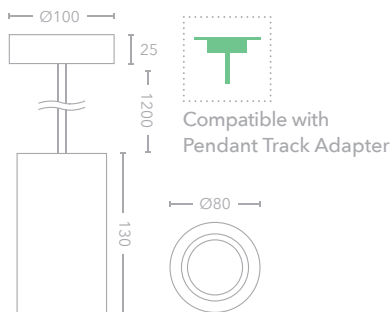

lyra flush

FL-LYRAW
 FL-LYRAB

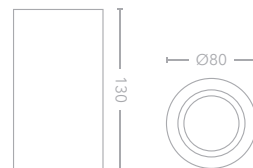

CLASS 1



DIMMABLE



TRACK
ADAPTER

Key Features

Sand white / silver interior

Sand black / gold interior

10W 3000K CREE COB LED

Beam angle: 36°

Mains dimmable

Height adjustable (Pendant only)

Lumens: White/silver 930 /
Black/gold 895

Power factor 0.9



AM-VUL2

AM-VUL4

vulcan 2ft

AM-VUL2 □

18W SMD LED

1700 lumens



vulcan 4ft

AM-VUL4 □

36W SMD LED

3000 lumens



CLASS 2

Key Features

White end caps / Aluminium body /
Opal Polycarbonate diffuser

3000K

Power factor: 0.9

Ceiling or wall mounted



Item no.	Power	CCT	Lumens	Diameter	Dimmable	Emergency /Sensor
AM-CORO12-3	12W	3000K	810	280mm	No	-
AM-CORO12-4	12W	4000K	830	280mm	No	-
AM-CORO25-3	25W	3000K	1970	350mm	Dimmable	-
AM-CORO25-3S	25W	3000K	1970	350mm	Dimmable	Sensor
AM-CORO25-3EM	25W	3000K	1970	350mm	Dimmable	Emergency
AM-CORO25-3EMS	25W	3000K	1970	350mm	Dimmable	Emergency & sensor
AM-CORO60-3	60W	3000K	4900	480mm	Dimmable	-
AM-CORO60-3S	60W	3000K	4900	480mm	Dimmable	Sensor
AM-CORO60-3EM	60W	3000K	4900	480mm	Dimmable	Emergency
AM-CORO60-3EMS	60W	3000K	4900	480mm	Dimmable	Emergency & sensor
AM-CORO25-4	25W	4000K	2020	350mm	Dimmable	-
AM-CORO25-4S	25W	4000K	2020	350mm	Dimmable	Sensor
AM-CORO25-4EM	25W	4000K	2020	350mm	Dimmable	Emergency
AM-CORO25-4EMS	25W	4000K	2020	350mm	Dimmable	Emergency & sensor
AM-CORO60-4	60W	4000K	5070	480mm	Dimmable	-
AM-CORO60-4S	60W	4000K	5070	480mm	Dimmable	Sensor
AM-CORO60-4EM	60W	4000K	5070	480mm	Dimmable	Emergency
AM-CORO60-4EMS	60W	4000K	5070	480mm	Dimmable	Emergency & sensor

Microwave motion sensor

- 30° - 150° detection angle
- 1 - 5m adjustable detection range
- 5s - 25min adjustable time setting
- 2 - 30 lux adjustable daylight threshold (can be disabled)

Emergency

- Maintained emergency function
- 3 hour emergency function
- Green indicator light

corona 12

AM-CORO12...
12W SMD LED



corona 25

AM-CORO25...
25W SMD LED



corona 60

AM-CORO60...
60W SMD LED



Key Features

- White painted steel / Opal Polycarbonate diffuser
- Power factor: 0.9
- Bathroom zone 2
- Ceiling or wall mounted
- Mains dimmable where applicable



blob pendant large

PE-BLOBL

GLS lamp shape

Class II

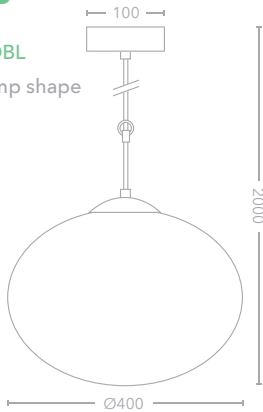

blob pendant medium

PE-BLOBM

GLS lamp shape

Class II

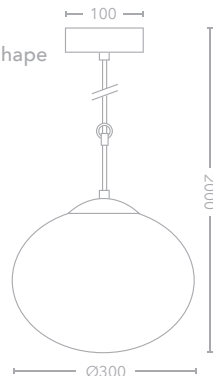

blob pendant small

PE-BLOBS

GLS lamp shape

Class II

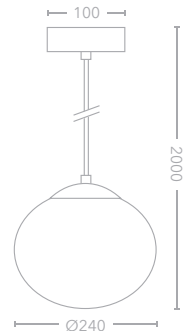



blob flush medium

FL-BLOBM
Class I

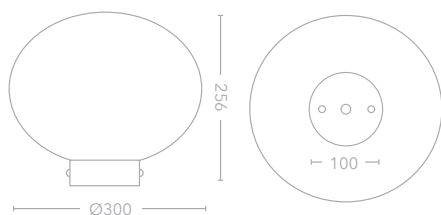

blob flush small

FL-BLOBS
Class I

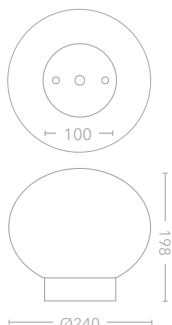

Key Features

Polished chrome metalwork /
Matt white glass

E27 Lampholder / 20W Max

LED only

The glass is handmade and there will always be very small variations between each piece



Compatible with
Pendant Track Adapter



SH-SF3-SN



SH-P3-SN

E27 3 light semi flush

SH-SF3-SN ■

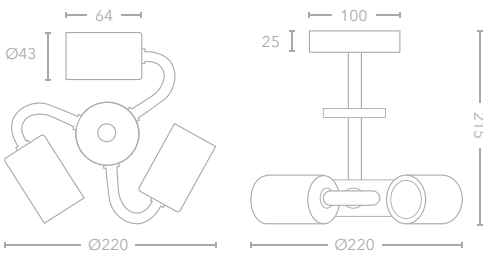

E27 3 light suspension

SH-P3-SN ■

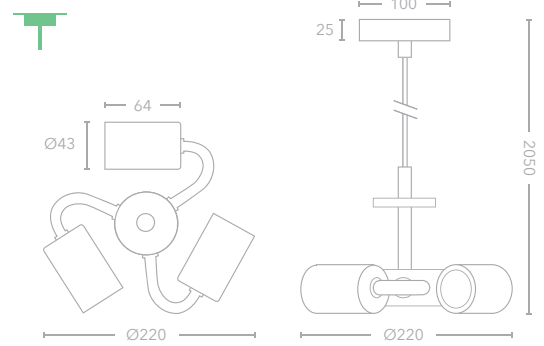



E27 suspension

SH-P1-SN ■

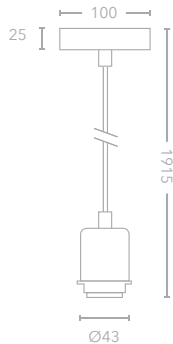

Compatible with
Pendant Track Adapter



CLASS 1



DIMMABLE



TRACK
ADAPTER

Key Features

E27 20W Max

1.8m Clear cable

LED only / 220-240V

IP20

Height adjustable

Suitable for:

Drum 30, Drum 40 & Drum 58 shades.

Shades available in colours:

Grey seal / Coconut / Mushroom





Wall

NEW



WL-SLO2-W

sloane 2

NEW

WL-SLO2-B ■ 500 lumens

WL-SLO2-W □ 525 lumens

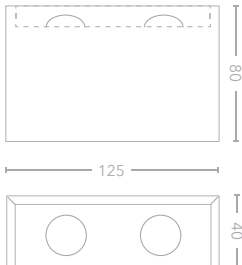

WL-SLO2-B



CLASS 1



DIMMABLE

Key Features

Sand Black / Sand White

Die cast steel body

6W LED

3000K

Power factor 0.9

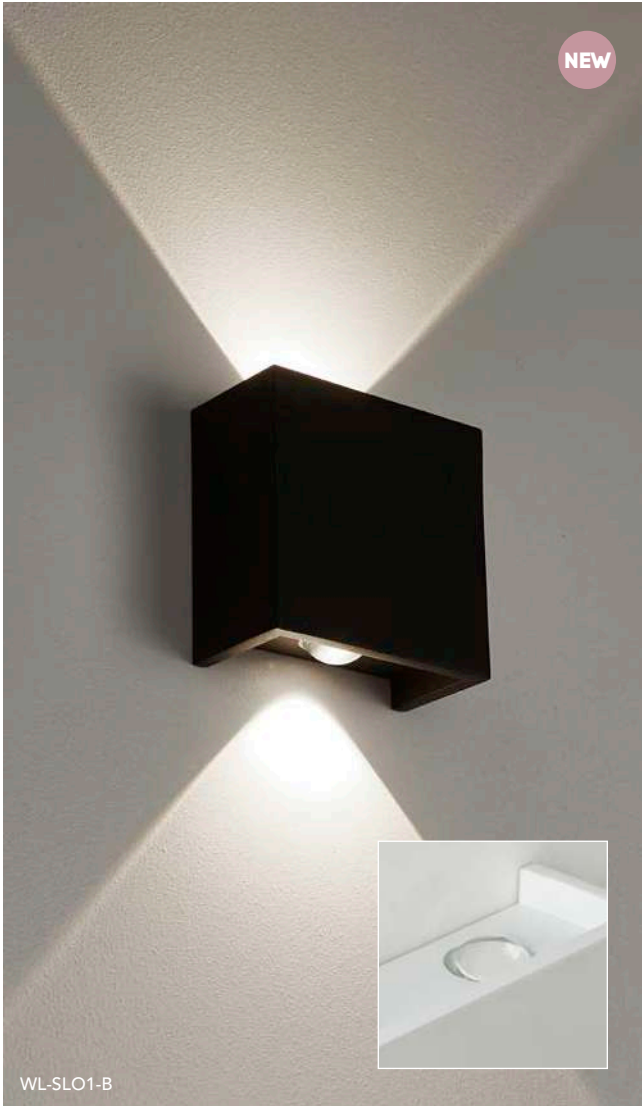

WL-SLO1-B



WL-SLO1-W

sloane 1

WL-SLO1-B ■ 260 lumens

WL-SLO1-W □ 280 lumens

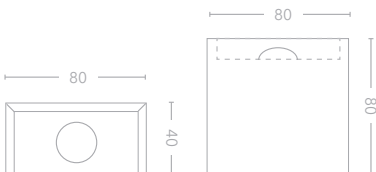

NEW



CLASS 1



DIMMABLE

Key Features

Sand Black / Sand White

Die cast steel body

4W LED

3000K

Power factor 0.9

NEW



WL-SOU24-B



WL-SOU24-W

NEW



WL-SHO20-B



WL-SHO20-W

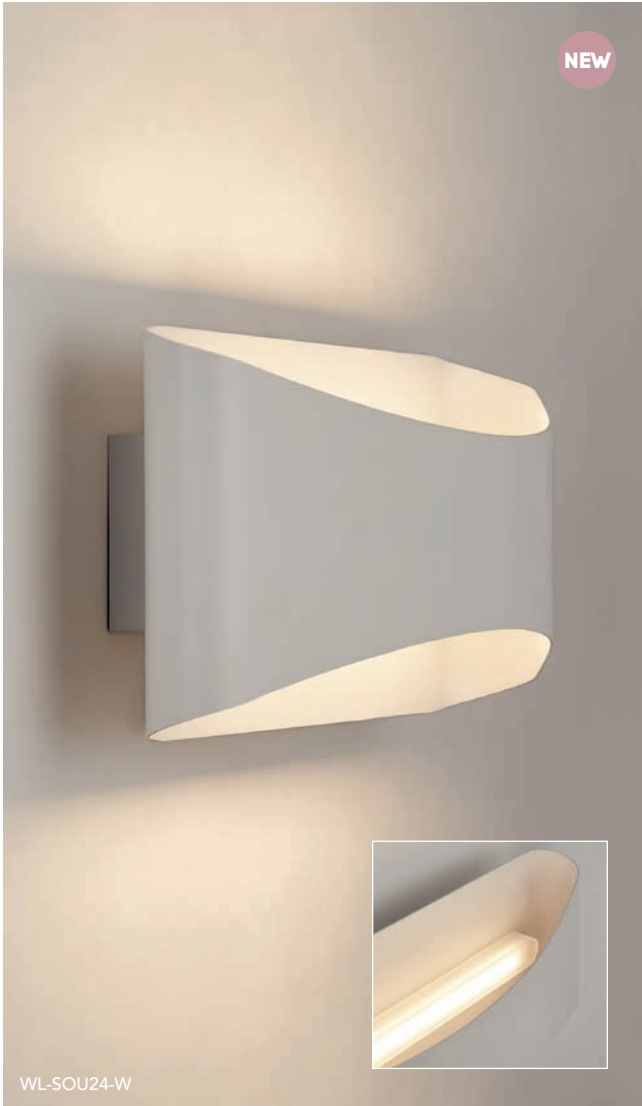

WL-SOU24-W



WL-SOU24-B



WL-SHO20-W



WL-SHO20-B

southwark

NEW

- WL-SOU24-B ■ 350 lumens
- WL-SOU24-W □ 720 lumens

shoreditch

NEW

- WL-SHO20-B ■ 580 lumens
- WL-SHO20-W □ 1040 lumens

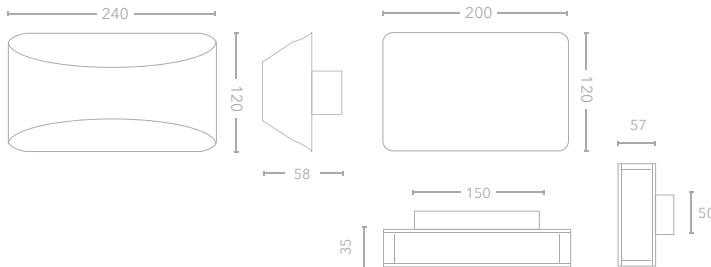

CLASS 1



DIMMABLE

Key Features

- Sand White / Sand Black
- Die cast aluminium / Acrylic
- SMD LED
- 3000K
- Power factor 0.9
- Southwark 11W
- Shoreditch 17W



ice

WL-ICE-B ■

WL-ICE-W □

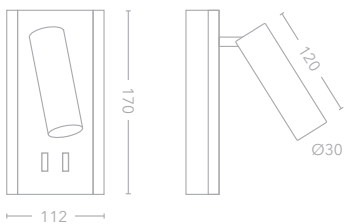

NEW



CLASS 1



SWITCH

Key Features

Sand White / Steel

8.5W SMD LED + 3W Power LED

3000K

Backlight / 280 lumens

Reading light / 170 lumens

Reading light pivots and rotates

Dual switching

Power factor 0.65



WL-HALK



WL-HALKB



WL-HALK

halkin

WL-HALKB
230 lumens



WL-HALK
450 lumens

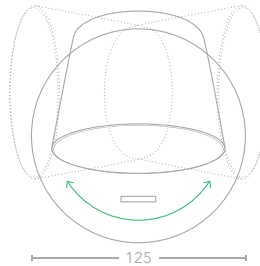
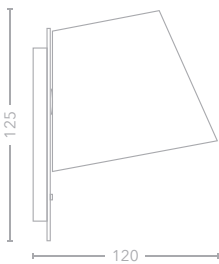

CLASS 1



SWITCH

Key Features

Sand white or black /
Die cast aluminum

6W Edison SMD LED

3000K

350° Rotation

Power factor 0.5





WL-LB10



WL-LB20



WL-LB38

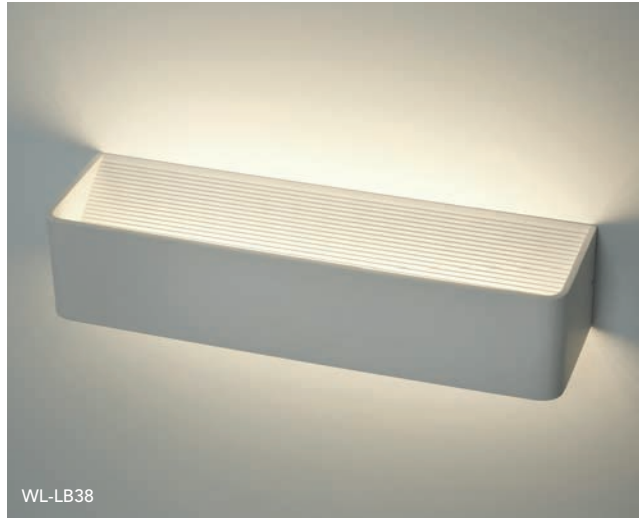

WL-LB38



WL-LB20

london bridge

WL-LB10
 6W EDISON COB
 450 lumens

WL-LB20
 6W EDISON SMD LED
 570 lumens

WL-LB38
 12W EDISON SMD LED
 1030 lumens

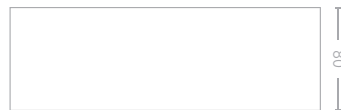
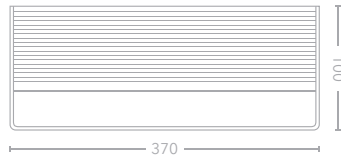
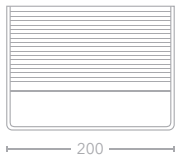

CLASS 1

Key Features

Sand white /
 Die cast aluminium

Integrated LED

3000K

Can be fitted vertically
 or horizontally



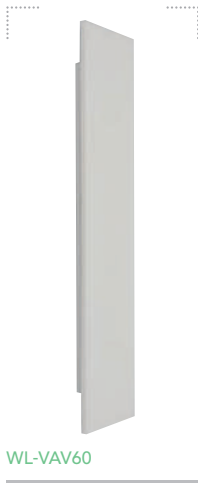

WL-VAV60

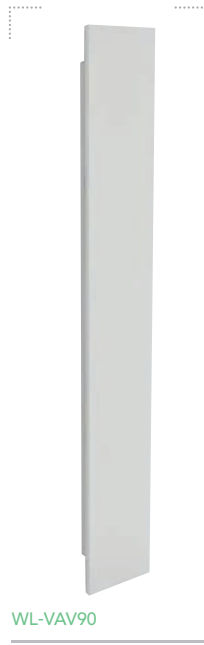

WL-VAV90



WL-VAV120

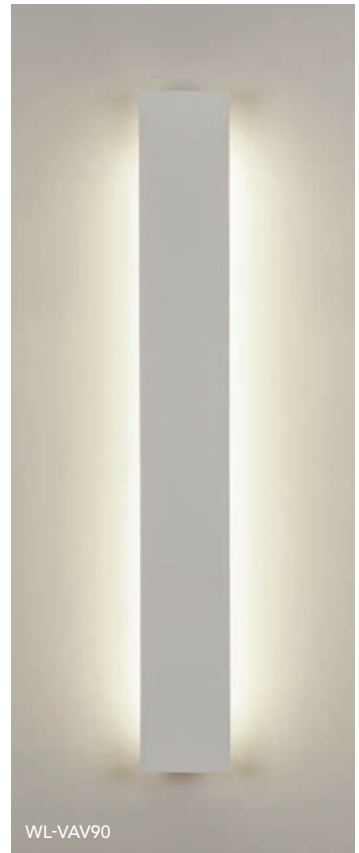

WL-VAV90

vavin 60

WL-VAV60
 12W SMD LED
 570 lumens



vavin 90

WL-VAV90
 20W SMD LED
 860 lumens



vavin 120

WL-VAV120
 30W SMD LED
 1220 lumens

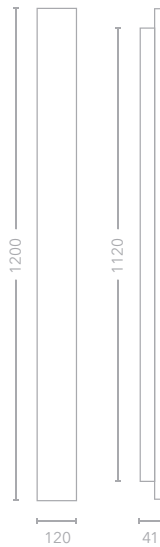

CLASS 2



DIMMABLE

Key Features

Sand white

Steel

3000K

220-240V

Can be fitted vertically
 or horizontally

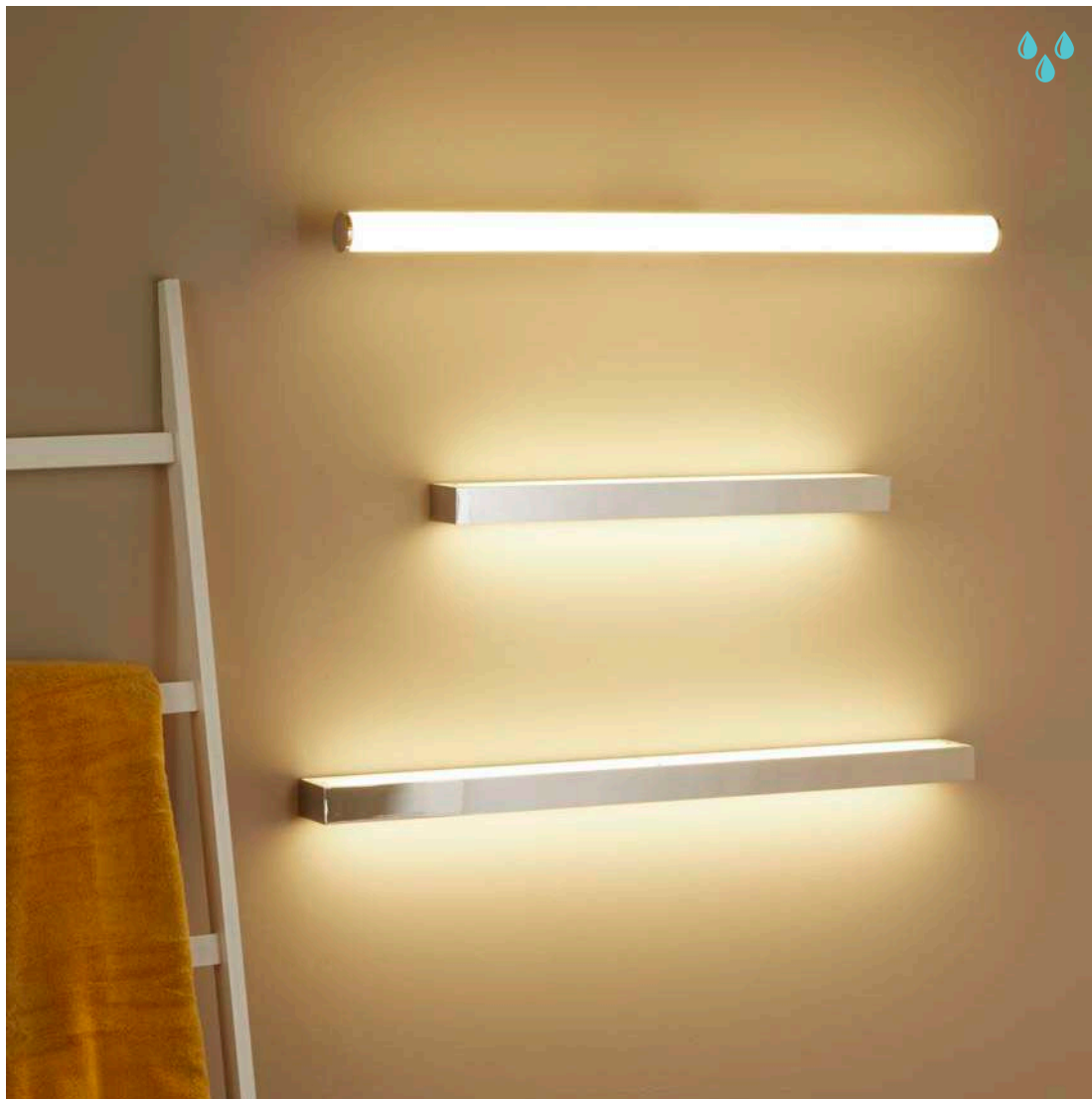

veritas

BA-VER90 
18W SMD LED
1570 lumens



CLASS 1



IP
44

Key Features

- Polished chrome /
- Opal Polycarbonate diffuser
- 3000K
- Ceiling or wall mounted
- Bathroom zone 2

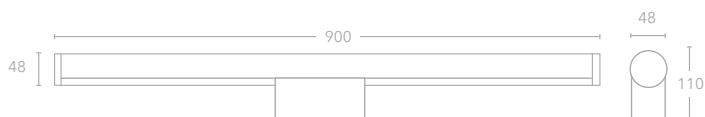



BA-VER90

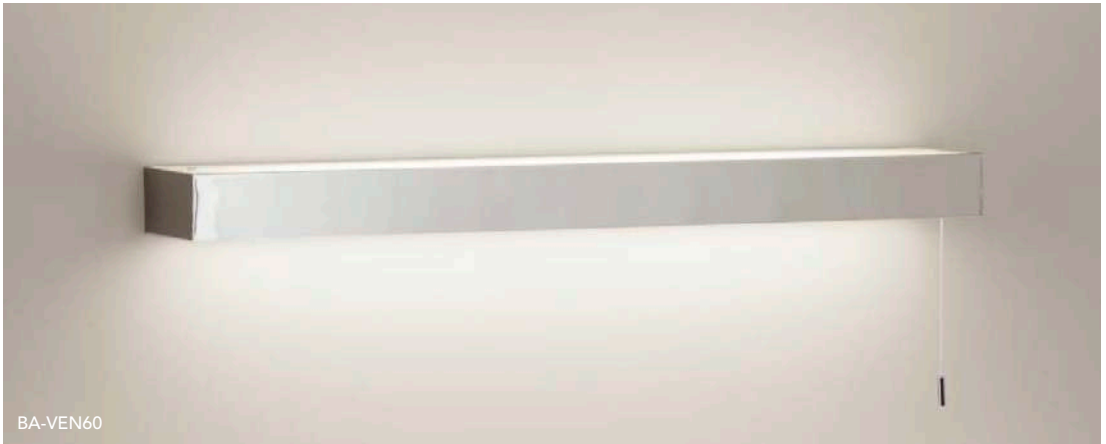

BA-VEN60



BA-VER90

venti 60

BA-VEN60 
18W SMD LED
870 lumens



venti 90

BA-VEN90 
24W SMD LED
1080 lumens



CLASS 1

IP
44

Key Features

Polished chrome /
Opal Polycarbonate / Frosted

3000K

Removable pull cord

Can be fitted vertically
or horizontally

Bathroom zone 2





WL-TU16



WL-OV25



WL-TU16



WL-OV25

tube 16

WL-TU16

ovo 25

WL-OV25



CLASS 2



DIMMABLE



GLASS

Key Features

Polished Chrome / Matt white glass

E14 LED only / Max 20W

Golf ball shape lamp required

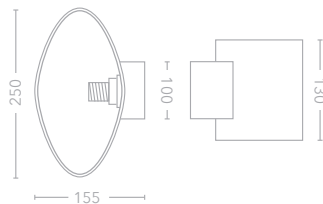
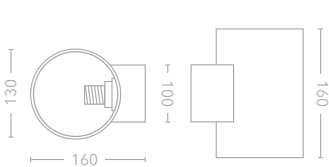

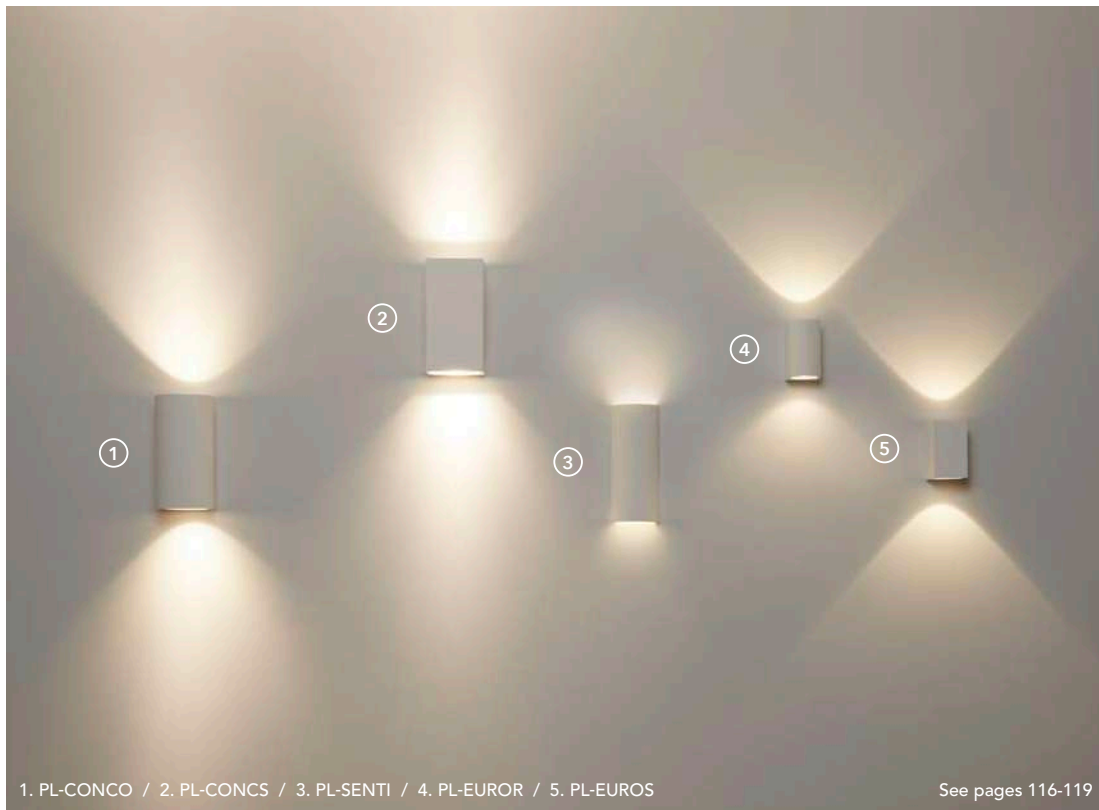

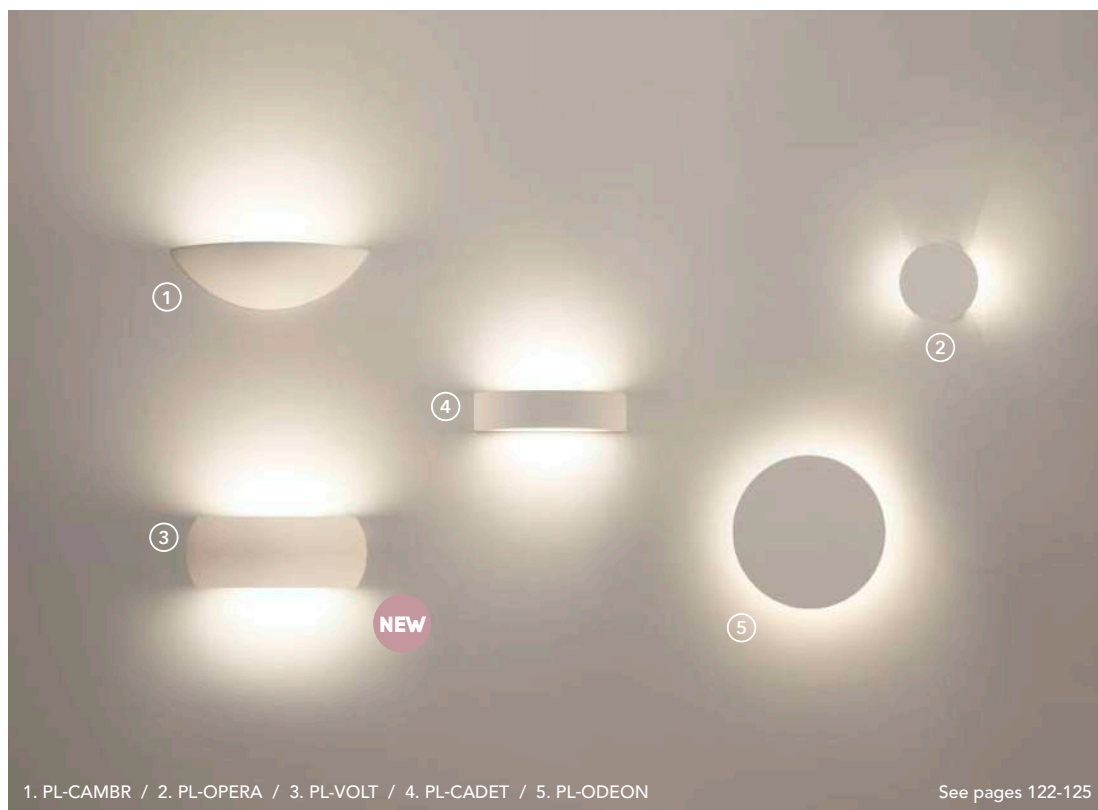

PAINTABLE

how to paint

All our plaster items are paintable. Follow these steps to achieve the best finish.

- seal the plaster with a PVA sealer (1 part PVA to 1 part water). allow to dry thoroughly
- paint with a soft brush. allow to dry
- lightly sand
- apply a second coat of paint with a soft brush
- this symbol represents a white plaster finish

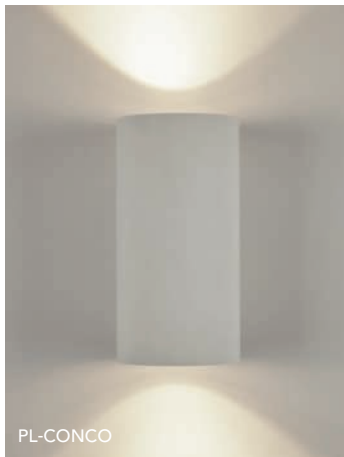

concorde round

PL-CONCO 

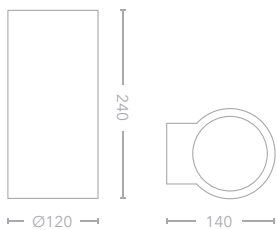

concorde square

PL-CONCS 

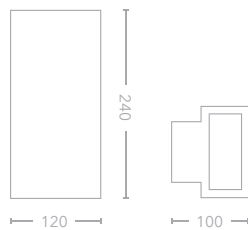

CLASS 2



DIMMABLE



PAINTABLE

Key Features

White plaster

2 x GU10 Lampholder

LED only / Max 10W each

220-240V



PL-EUROR

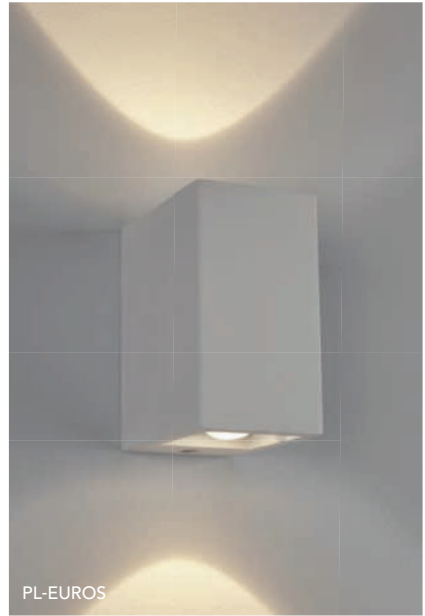

PL-EUROS



PL-EUROS

europa round

PL-EUROR 

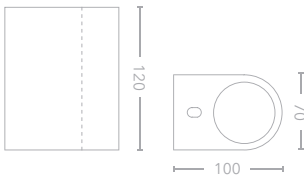

europa square

PL-EUROS 

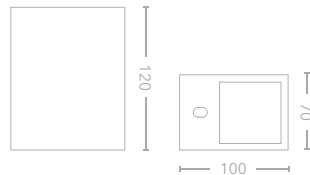

CLASS 2



PAINTABLE

Key Features

White plaster

2 x 3W CREE LED

450 lumens

3000K

220-240V



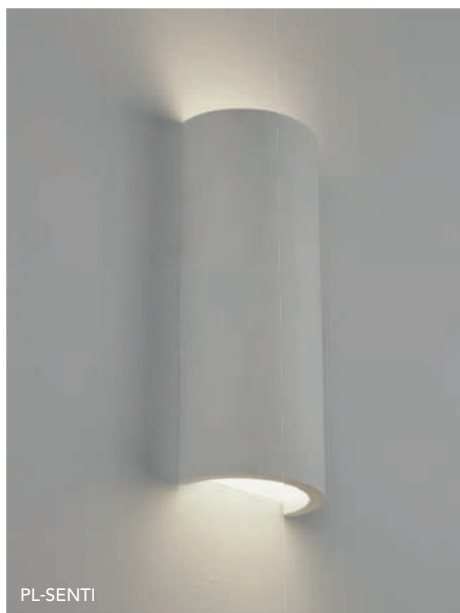

PL-SENTI



PL-MIRAB



PL-MONCE

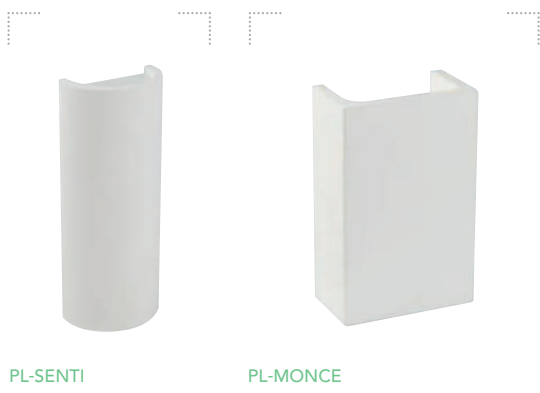

PL-SENTI

PL-MONCE

sentier

PL-SENTI 

2 x 1.5W Power LED
245 lumens

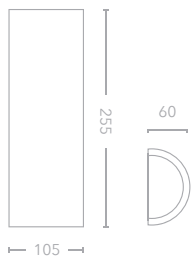

mirabeau

PL-MIRAB 

2 x 3W CREE LED
410 lumens

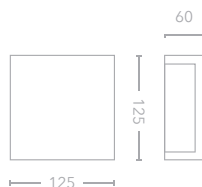

monceau

PL-MONCE 

2 x 3W CREE LED
510 lumens

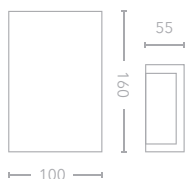

PAINTABLE

Key Features

White plaster

3000K

Mirabeau & Monceau (Class I)

Sentier (Class II)

220-240V



PL-MABIL



PL-MABIL

mabillon

PL-MABIL 

570 lumens

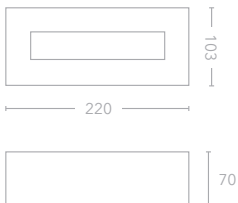

CLASS 1



PAINTABLE

Key Features

White plaster

5W CREE LED

3000K

220-240V

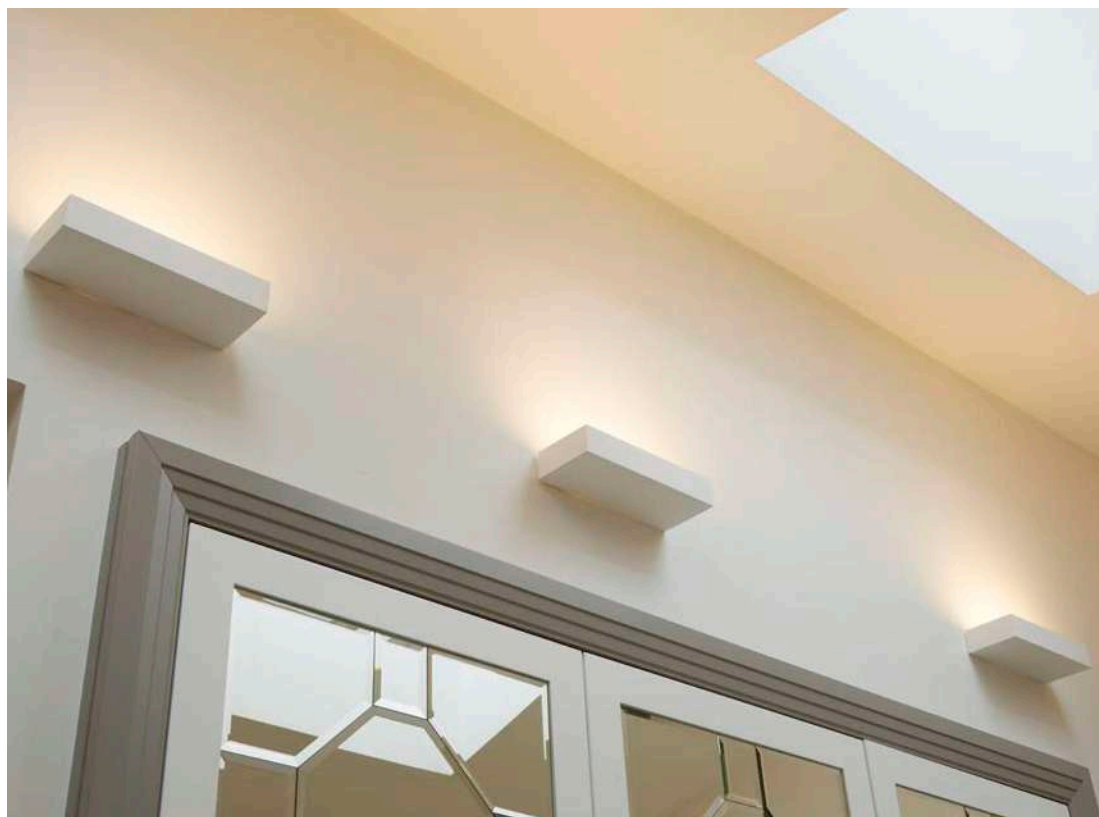

PL-AVRON



PL-AVRON

avron

PL-AVRON 

600 lumens



CLASS 2



PAINTABLE

Key Features

White plaster

6.5W SMD LED

3000K

220-240V





PL-CADET



PL-VOLT



PL-CADET



PL-VOLT

cadet

PL-CADET 
 6.5W SMD LED
 550 lumens

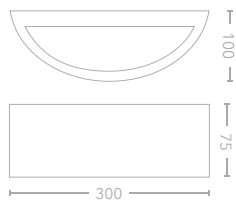

voltaire

PL-VOLT 
 E27 20W Max

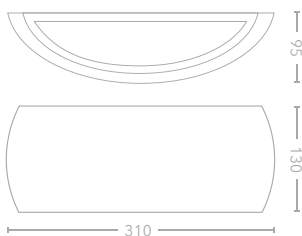

NEW



CLASS 2



PAINTABLE

Key Features

White plaster

3000K

220-240V



cambronne

PL-CAMBR 

600 lumens

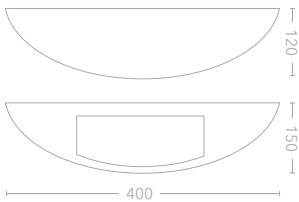

CLASS 2



PAINTABLE

Key Features

White plaster

10W SMD LED

3000K

220-240V

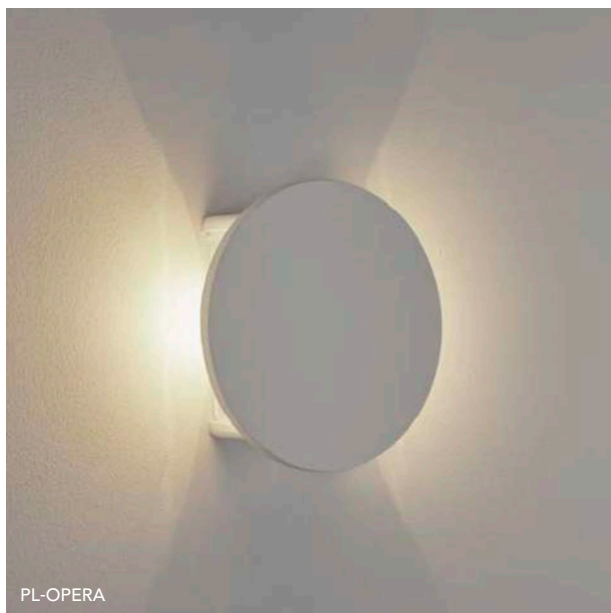

PL-OPERA



PL-ODEON



PL-OPERA

odeon

opera

PL-ODEON 

10W SMD LED

620 lumens

PL-OPERA 

2 x 1.5W LED

175 lumens

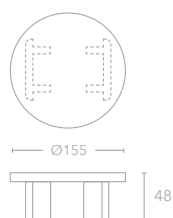
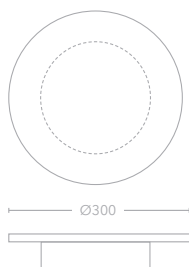

CLASS 2



PAINTABLE

Key Features

White plaster

3000K

220-240V





LED-PROJ1W-B



LED-PROJ1W-W



LED-PROJ1W-SN



Driver:
Supplied separately



mini projector

- LED-PROJ1W-B ■
 - LED-PROJ1W-W □
 - LED-PROJ1W-SN ■
- 120 lumens

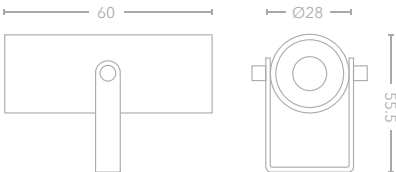

CLASS 3



DIMMABLE



350mA

Key Features

Aluminium body

1W CREE XPE 3000K

Beam angle: 20°

270° Pivot / 360° Rotation

Driver supplied separately

Fittings must be wired in series

Can be wall, ceiling or floor mounted



SH-US-M



SH-US-C



SH-UD-C



SH-UD-M



SH-UWB

universal half drum

- SH-UD-C ■
- SH-UD-M ■

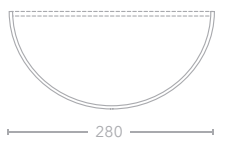

universal half square

- SH-US-C ■
- SH-US-M ■

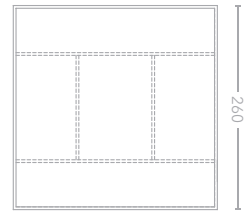

SH-UWB

Universal wall bracket
Class I / Switch
Dimmable

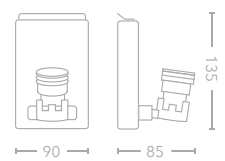



universal half cylinder

- SH-UC-C ■
- SH-UC-M ■

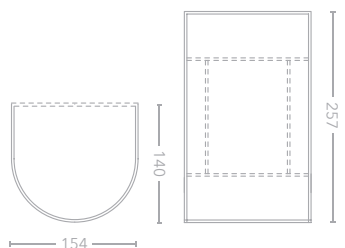

universal half rectangle

- SH-UR-C ■
- SH-UR-M ■

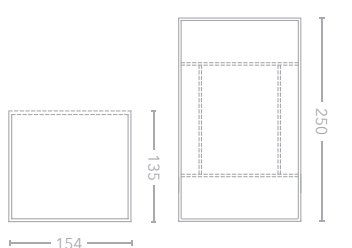

CLASS 1



SWITCH



DIMMABLE

Key Features

Polycotton shade / PVC lining

For use with SH-UWB only
Universal shade wall bracket
sold separately

E27 20W Max

LED only

To Order: SH-UWB + SH-UC- Colour e.g. SH-UWB + SH-UC-C



SH-WBPIM-AB



SH-WBPIM-MB



SH-WBPIM-SN



SH-WBPIM-CP

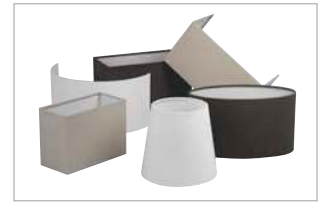

Shades:
Supplied separately
See pages 150-155

pimlico

- SH-WBPIM-AB ■
- SH-WBPIM-CP ▨
- SH-WBPIM-SN ■
- SH-WBPIM-MB ■

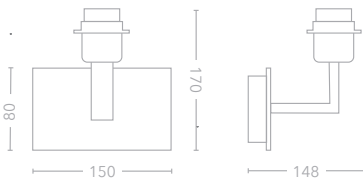

CLASS 1



SWITCH

Key Features

Steel

E27 GLS LED max 20W

LED only



SH-WBPIMR-CP



SH-WBPIMR-SN



SH-WBPIMR-MB



SH-WBPIMR-SN



Shades:
Supplied separately
See pages 150-155

pimlico reader

- SH-WBPIMR-AB ■
- SH-WBPIMR-CP ■
- SH-WBPIMR-SN ■
- SH-WBPIMR-MB ■

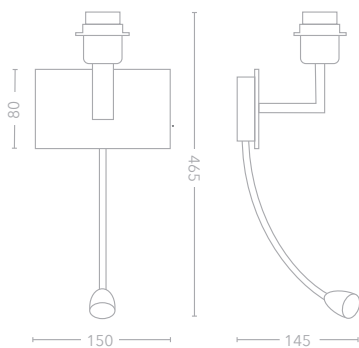

CLASS 1



SWITCH

Key Features

Steel

E27 GLS LED max 20W

LED only

Reading Arm

1W 3000K LED / 90 lumens

30° Beam angle

Replaceable LED Module MOD1W

Dual switching



SH-WBPIMP-CP



SH-WBPIMP-AB



SH-WBPIMP-SN

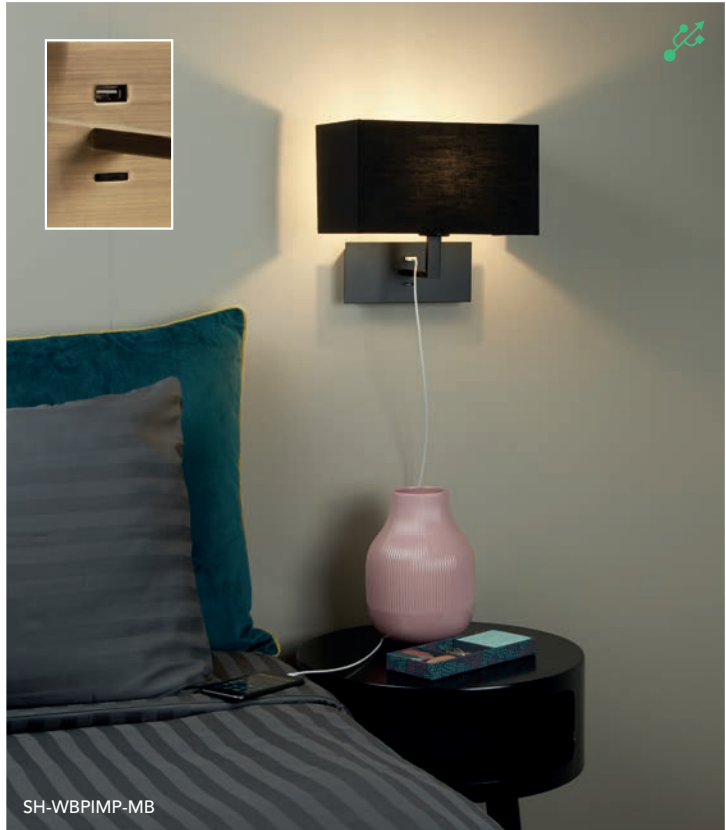

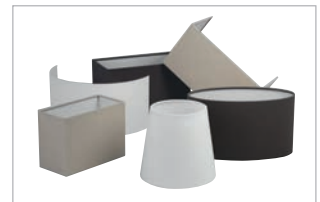

SH-WBPIMP-MB



Shades:
Supplied separately
See pages 150-155

pimlico plus

- SH-WBPIMP-AB 
- SH-WBPIMP-CP 
- SH-WBPIMP-SN 
- SH-WBPIMP-MB 

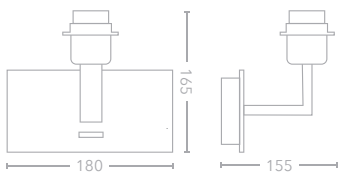

CLASS 1



SWITCH



USB

Key Features

Steel

E27 GLS LED max 20W

LED only

Switches on the front plate



SH-WBPIMPR-CP



SH-WBPIMPR-AB



SH-WBPIMPR-MB

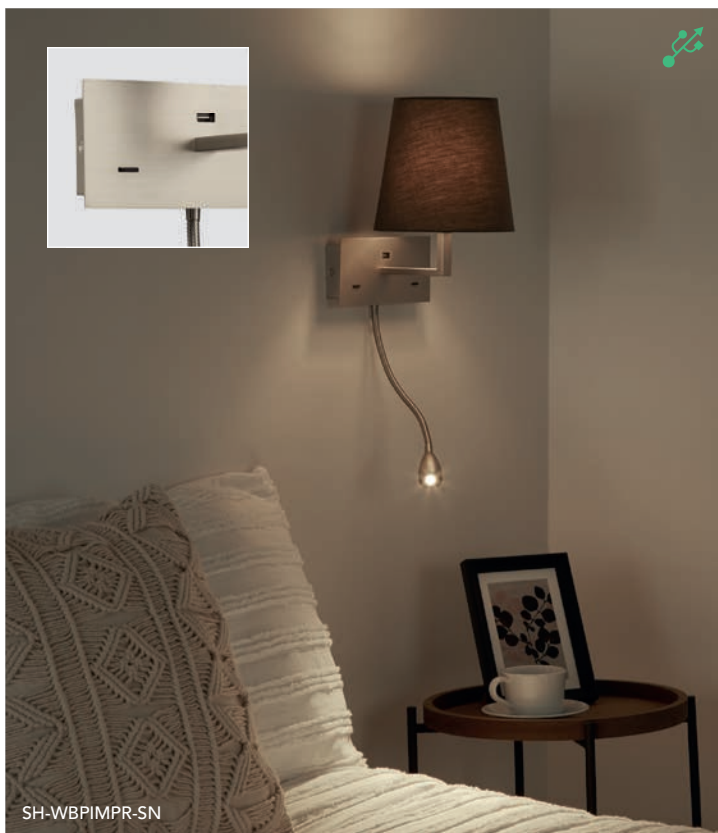

SH-WBPIMPR-SN



Shades:
Supplied separately
See pages 150-155

pimlico plus reader

- SH-WBPIMPR-AB
- SH-WBPIMPR-CP
- SH-WBPIMPR-SN
- SH-WBPIMPR-MB

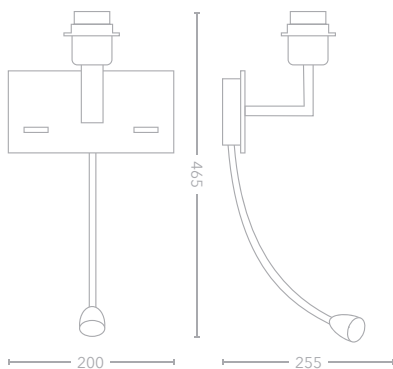

- 
CLASS 1
- 
SWITCH
- 
USB

Key Features

- Steel
- E27 GLS LED max 20W
- LED only
- Switches on the front plate

Reading Arm

- 1W 3000K LED / 90 lumens
- 30° Beam angle
- Replaceable LED Module MOD1W
- Dual switching



SH-WBFEN-SN



SH-WBFEN-SN



Shades:
Supplied separately
See pages 150-155

fenchurch

SH-WBFEN-SN ■

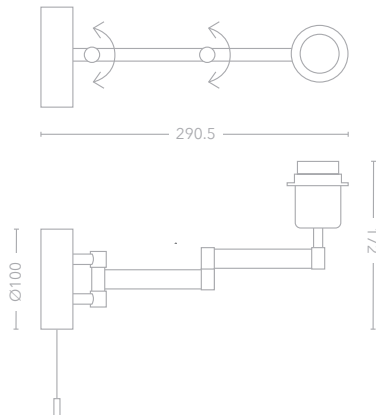

CLASS 2



SWITCH



DIMMABLE

Key Features

Steel

Double articulated arm

E27 LED max 20W

Removable pull cord switch

Recommended shades

SHDR15 & SH-CO, see page 152



SH-WBVIC-AB



SH-WBVIC-MB



SH-WBVICR-SN



SH-WBVIC-SN



Shades:
Supplied separately
See pages 150-155

victoria

- SH-WBVIC-AB ■
- SH-WBVIC-SN ■
- SH-WBVIC-MB ■

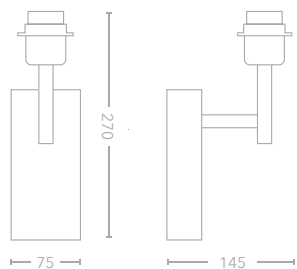

victoria reader

- SH-WBVICR-AB ■
- SH-WBVICR-SN ■
- SH-WBVICR-MB ■

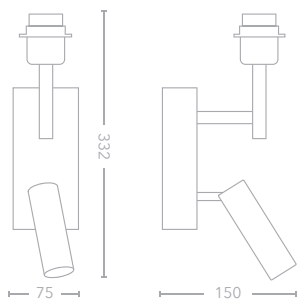

CLASS 1



SWITCH

Key Features

Steel

E27 GLS LED max 20W

LED only

Reading Arm

1W 3000K LED

90 lumens

30° Beam Angle

Replaceable LED module MOD1W

Dual switching



SH-VICLED-AB



SH-VICLED-SN



SH-VICLED-CP



SH-VICLED-MB

victoria LED

- SH-VICLED-AB
- SH-VICLED-SN
- SH-VICLED-MB
- SH-VICLED-CP

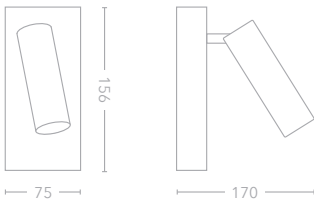

CLASS 1



SWITCH

Key Features

Steel

Adjustable / Pivoting reading light

1W CREE XPE LED

3000K

90 lumens

30° Beam angle

Replaceable LED module MOD1W



SH-VICLEDR-AB



SH-VICLEDR-MB



SH-VICLEDR-SN



SH-VICLEDR-SN

victoria LED recessed

- SH-VICLEDR-AB
- SH-VICLEDR-SN
- SH-VICLEDR-MB

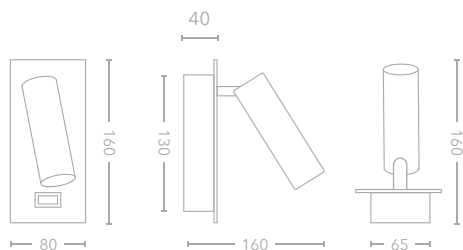

CLASS 1



SWITCH



USB



CUT OUT
67x132mm

Key Features

Steel

Adjustable / Pivoting reading light

1W CREE XPE LED

USB Charger

3000K / 90 lumens

30° Beam angle

Replaceable LED module MOD1W





WL-CHER-AB



WL-CHE-AB



chelsea recessed

- WL-CHER-AB ■
- WL-CHER-SN ■

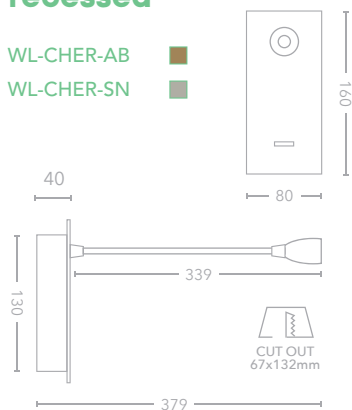

chelsea

- WL-CHE-AB ■
- WL-CHE-SN ■

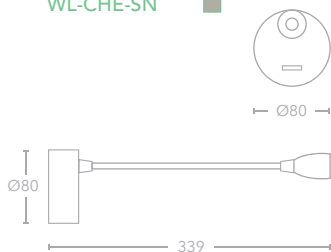

CLASS 1



SWITCH

Key Features

- Steel
- Adjustable / Pivoting reading light
- 1W CREE XPE LED
- 3000K
- 90 lumens
- 30° Beam angle
- Replaceable LED module MOD1W



table & floor







TA-LIB-B



FS-LIB-W



TA-LIB-W

libra table

- TA-LIB-B
- TA-LIB-W

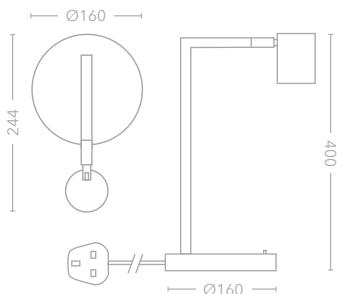

libra floor

- FS-LIB-B
- FS-LIB-W

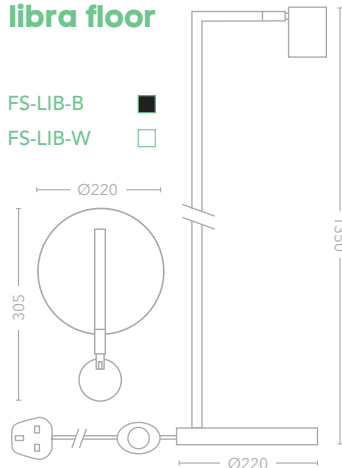

Key Features

- Sand black / Sand white
- Die cast construction
- GU10 max. 10W LED only
- Linear switch on base of table lamp
- Inline switch on cable of floor lamp

For European plug use code
EUTA-LIB.**
EUFS-LIB.**





TA-KEN-SN

FS-KEN-SN



FS-KEN-SN
TA-KEN-SN

SH-RXL-M
SH-RL-G

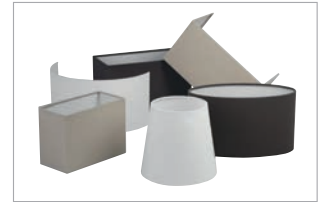

Shades:
Supplied separately
See pages 150-155

kensington table

TA-KEN-SN

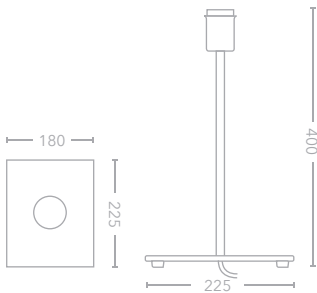

Recommended shade: SH-RL

kensington floor

FS-KEN-SN

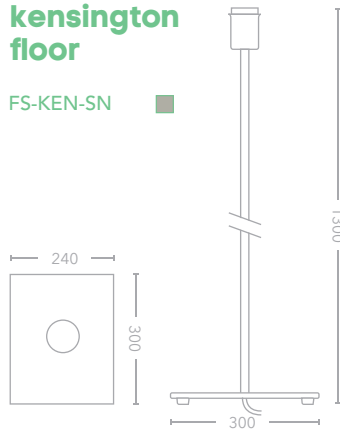

Recommended shade: SH-RXL



CLASS 2



SWITCH

Key Features

Satin nickel finish

E27 max. 20W

LED only

Inline switch on cable

Shades supplied separately

For European plug use code
EUTA-KEN-SN
EUFS-KEN-SN



TA-OLY-AB-USB

TA-OLY-AB-USB

SH-DR30-M

olympia table USB

TA-OLY-AB-USB 

TA-OLY-SN-USB 

With USB charging port

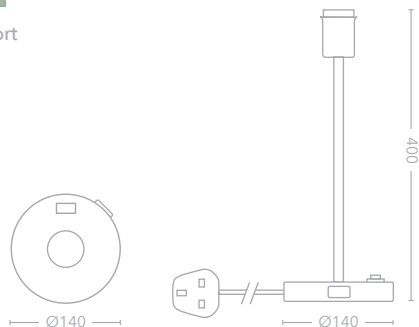

CLASS 2



SWITCH

Key Features

Antique brass, Satin nickel finishes

E27 max. 20W / LED only

Switch on base

Shades supplied separately

For European plug use code
EUTA-OLY-**



FS-OLY-SN + SH-DR40-B

SH-DR30-B

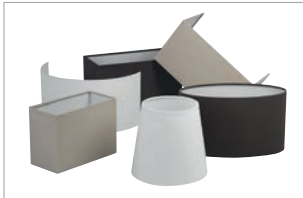

Shades:
Supplied separately
See pages 150-155



TA-OLY-SN



FS-OLY-AB

olympia table

- TA-OLY-AB ■
- TA-OLY-SN ■

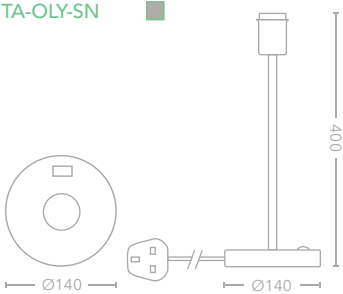

Recommended shade: SH-DR30 / SH-OVM

olympia floor

- FS-OLY-AB ■
- FS-OLY-SN ■

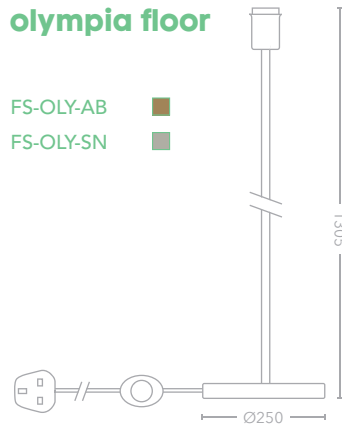

Recommended shade: SH-DR40 / SH-OVL



Key Features

- E27 max. 20W / LED only
- Floor lamp has inline switch on cable
- Table lamp has switch on base
- Shades supplied separately

For European plug use code
EUTA-OLY-**
EUFS-OLY-**



shades



shades

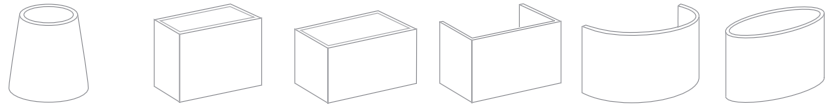

Colour		Cone	Small Rectangle	Large Rectangle	Open Square	Open Crescent	Small Oval
	Coconut	SH-CO-C	SH-RS-C	SH-RL-C	SH-SQO-C	SH-CR-C	SH-OV-C
	Mushroom	SH-CO-M	SH-RS-M	SH-RL-M	SH-SQO-M	SH-CR-M	SH-OV-M
	Grey Seal	SH-CO-G	SH-RS-G	SH-RL-G	SH-SQO-G	SH-CR-G	SH-OV-G
	Black	SH-CO-B	SH-RS-B	SH-RL-B	SH-SQO-B	SH-CR-B	SH-OV-B

Range	Page no.						
1lt Suspension	97						
3lt Suspension	96						
3lt Semi-flush	96						
Pimlico	130, 131	●	●	●	●	●	●
Pimlico Plus	132, 133	●	●	●	●	●	●
Victoria	135	●	●	●	●	●	●
Fenchurch	136	●					
Kensington Table	145	●		●			●
Kensington Floor	145			●			
Olympia Table	146, 147	●		●			●
Olympia Floor	147						

Key

- C - Coconut
- M - Mushroom
- G - Grey seal
- B - Black

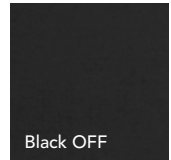
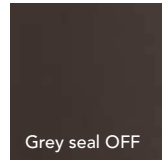
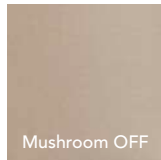
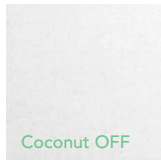

Shade material without light source



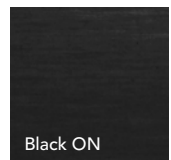
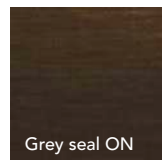
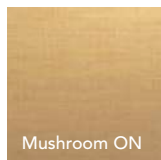
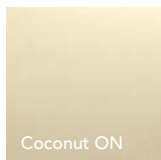



















Shade material with 3000K light source





Medium Oval	Large Oval	X-Large Rectangle	Drum 15	Drum 30	Drum 40	Drum 58
SH-OVM-C	SH-OVL-C	SH-RXL-C	SH-DR15-C	SH-DR30-C	SH-DR40-C	SH-DR58-C
SH-OVM-M	SH-OVL-M	SH-RXL-M	SH-DR15-M	SH-DR30-M	SH-DR40-M	SH-DR58-M
SH-OVM-G	SH-OVL-G	SH-RXL-G	SH-DR15-G	SH-DR30-G	SH-DR40-G	SH-DR58-G
SH-OVM-B	SH-OVL-B	SH-RXL-B	SH-DR15-B	SH-DR30-B 	SH-DR40-B 	SH-DR58-B 

All the shades in this collection are:

- White PVC lining
- To suit E27/E14/B22 shade ring
- For use with LED lamps only
- Available from stock in the UK
- Flame retardant



Special colours available

Minimum order quantities will apply.
Allow 4 weeks for a sample and
12 weeks order lead time.

Not all items are stocked in black. Minimum quantity for special orders: 100

cone



SH-CO-M

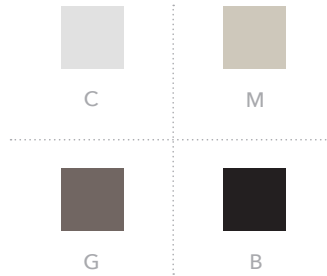

- SH-CO-C
- SH-CO-M
- SH-CO-G
- SH-CO-B

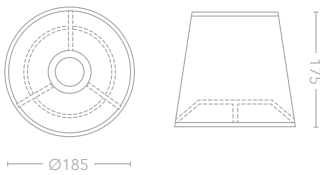

open crescent



SH-CR-C

- SH-CR-C
- SH-CR-M
- SH-CR-G
- SH-CR-B

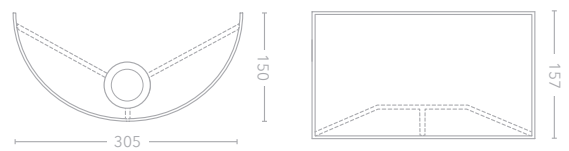

small oval



SH-OV-G

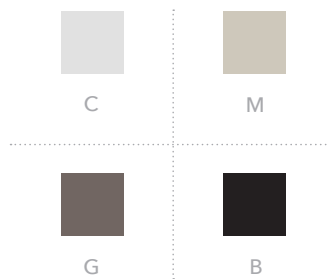

- SH-OV-C
- SH-OV-M
- SH-OV-G
- SH-OV-B

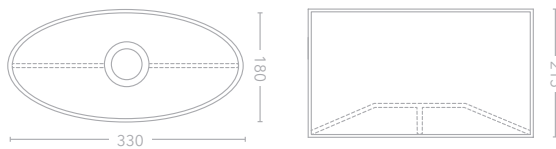

drum 15



SH-DR15-M

- SH-DR15-C
- SH-DR15-M
- SH-DR15-G
- SH-DR15-B

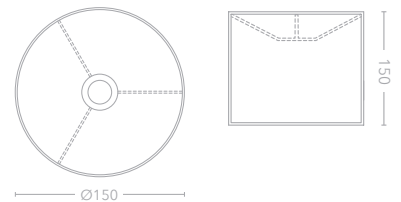

small rectangle



SH-RS-B

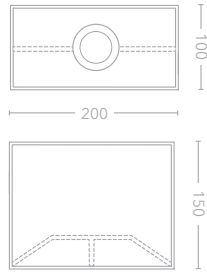

C



M



G



B



SH-RS-C



SH-RS-M



SH-RS-G



SH-RS-B

large rectangle



SH-RL-M

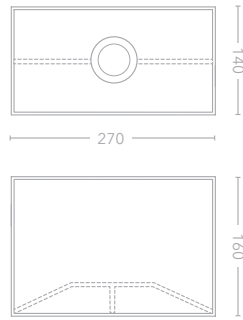

C



M



G



B



SH-RL-C



SH-RL-M



SH-RL-G



SH-RL-B

open square



SH-SQO-C

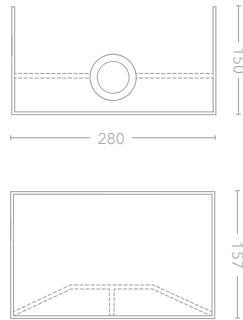

C



M



G



B



SH-SQO-C



SH-SQO-M



SH-SQO-G



SH-SQO-B

medium oval



SH-OVM-M

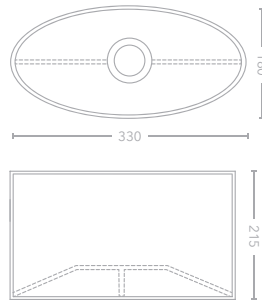

C



M



G



B

SH-OVM-C

SH-OVM-G

SH-OVM-M

SH-OVM-B

large oval



SH-OVL-C

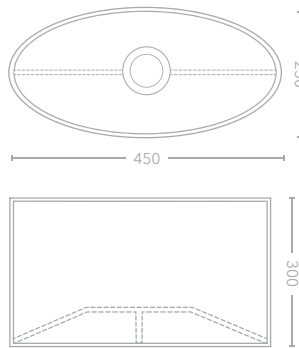

C



M



G



B

SH-OVL-C

SH-OVL-G

SH-OVL-M

SH-OVL-B

x-large rectangle



SH-RXL-B

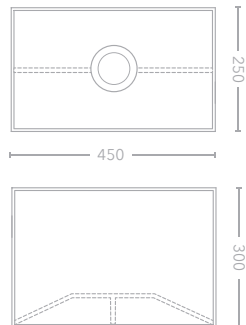

C



M



G



B

SH-RXL-C

SH-RXL-G

SH-RXL-M

SH-RXL-B

drum 30



SH-DR30-G

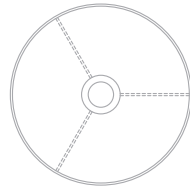

Ø300

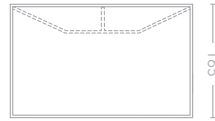

165



C



M



G



B

SH-DR30-C

SH-DR30-M

SH-DR30-G

SH-DR30-B

drum 40



SH-DR40-M

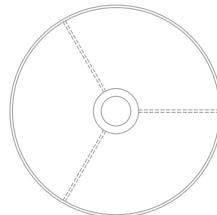

Ø400

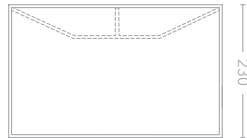

230



C



M



G



B

SH-DR40-C

SH-DR40-M

SH-DR40-G

SH-DR40-B

SH-DIF40 Parchment effect PVC diffuser
available as optional extra

drum 58



SH-DR58-C

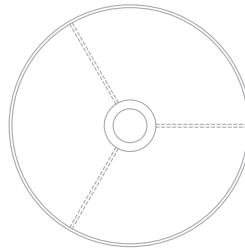

Ø580

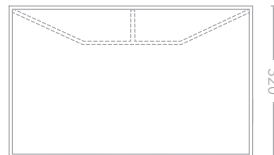

320



C



M



G



B

SH-DR58-C

SH-DR58-M

SH-DR58-G

SH-DR58-B

SH-DIF58 Parchment effect PVC diffuser
available as optional extra





outdoor



Adjustable beam angles



OD-STR-G



OD-MAY-G



OD-STR-G



OD-MAY-G

strand adjustable

OD-STR-G ■
 2 x 7W CREE LED
 Max. 550 lumens
 Power factor 0.95

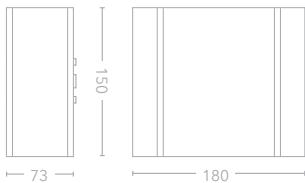

mayfair adjustable

OD-MAY-G ■
 2 x 3W CREE LED
 Max. 251 lumens
 Power factor 0.5

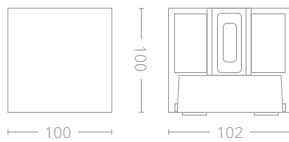

CLASS 1



IP 65

Key Features

Graphite / Die cast aluminium
 3000K

Adjustable shutters top and bottom to change the beam angles independently





OD-BER1-G



OD-BER1-G



OD-BER2-G

berkeley I

OD-BER1-G ■
 8W CREE COB LED
 890 lumens
 IP65

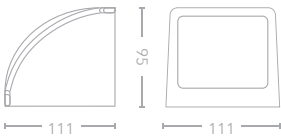

berkeley II

OD-BER2-G ■
 8W Osram LED
 825 lumens
 IP54

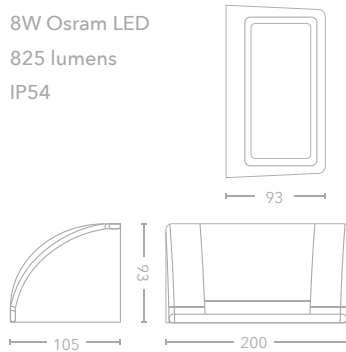

CLASS 1



IP



GLASS

Key Features

Graphite / Die cast aluminium

3000K

Power factor 0.9

Fit facing downwards





OD-CLA-G



OD-CLA-G



OD-LAN-G



OD-LAN-G

claridges

OD-CLA-G ■
2 x 6W CREE COB
1030 lumens

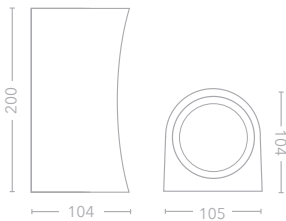

lanesborough

OD-LAN-G ■
2 x 6W Osram LED
1000 Lumens

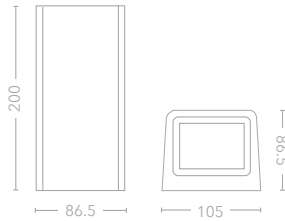

CLASS 1



IP 65



GLASS

Key Features

Graphite / Die cast aluminium

3000K

Beam Angle 2 x 60°

Power Factor 0.95





OD-WAL1-G



OD-WAL2-G



OD-CON-G



OD-WAL1-G



OD-WAL2-G



OD-CON-G

waldorf I

OD-WAL1-G ■
 3W COB LED
 180 Lumens
 0.4 Power factor
 60° Beam angle

waldorf II

OD-WAL2-G ■
 2x 3w COB LED
 360 Lumens
 0.5 Power factor
 60° Beam angle

connaught

OD-CON-G ■
 2 x 6W CREE COB LED
 910 Lumens
 0.95 Power factor
 90° Beam angle



CLASS 1



IP 65



GLASS

Key Features

Graphite finish

Die cast aluminium

3000K

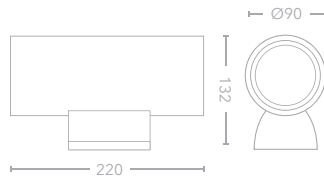
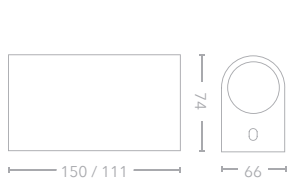



OD-DORB80-G



OD-DORW-G

dorchester wall light

OD-DORW-G ■
 8W CREE COB LED
 580 lumens
 Wall mounted

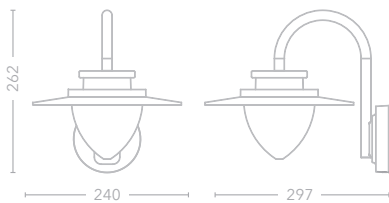

dorchester 80cm post

OD-DORB80-G ■
 8W CREE COBLED
 580 lumens
 Floor mounted

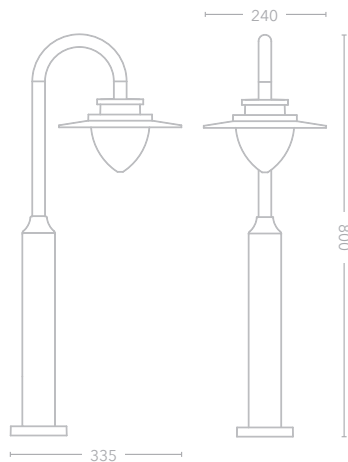

CLASS 1



IP 54

Key Features

Graphite /
 Die cast aluminium /
 Opal PC diffuser

3000K

Power factor 0.9



OD-SAN80-G



outdoor

OD-SAN80-G

sanderson bollard

OD-SAN80-G ■
8W OSRAM COB LED
700 lumens
360° Beam angle
IP44



CLASS 1



IP
44

Key Features

Graphite body /
Die cast aluminium / Polycarbonate
3000K
Power factor 0.9



grosvenor bollard 80

OD-GRO80-G ■
8W CREE COB LED
600 lumens



grosvenor bollard 30

OD-GRO30-G ■
8W CREE COB LED
600 lumens

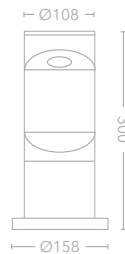

NEW



CLASS 1



IP 54

Key Features

Graphite body

Die cast aluminium

3000K

Power factor 0.9

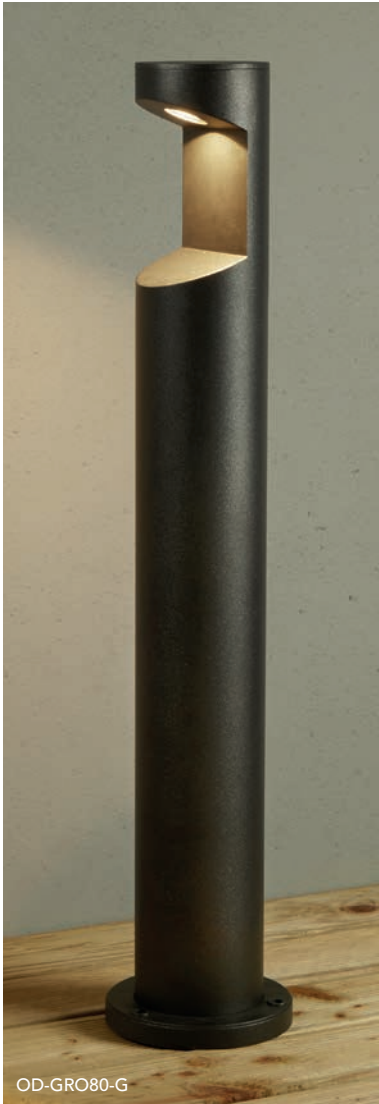

OD-GRO280-G



OD-GRO230-G

grosvenor II bollard 80

OD-GRO280-G ■
12W Lumileds COB LED
660 lumens

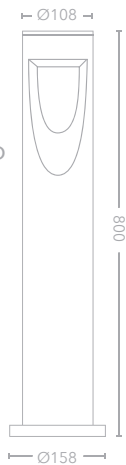

grosvenor II bollard 30

OD-GRO230-G ■
12W Lumileds COB LED
660 lumens

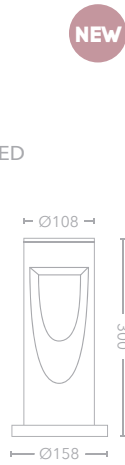

Key Features

Graphite body

Die cast aluminium

3000K

Power factor 0.9





outdoor

OD-FARR / OD-FARR700

farringdon spike spot

OD-FARR ■
 230V / Class I
 CREE COB
 670 Lumens
 0.55 Power Factor

farringdon spike spot 700mA

OD-FARR700 ■
 700mA / Class III
 CREE COB
 670 Lumens
 Separate driver required
 Dimmable when used
 with a dimmable driver

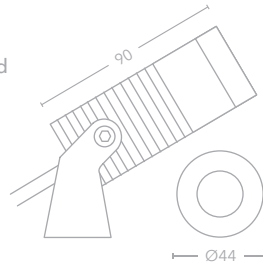

Key Features

Passivated black / Aluminium
 8W CREE COB
 3000K
 Corrosion resistant
 240mm Plastic spike included
 Pre-fitted with 24° lens
 Spare 10° lens included





Driver:
Supplied separately
See page 190



**4 way
plot light**

IPR-PLOT4SS

4 x 70° Beam



**3 way
plot light**

IPR-PLOT3SS

3 x 70° Beam



**2 way
plot light**

IPR-PLOT2SS

2 x 110° Beam



**1 way
plot light**

IPR-PLOT1SS

110° Beam

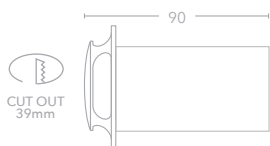
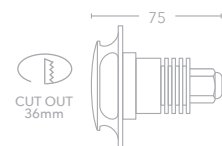
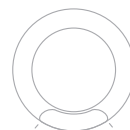

Includes
installation
tube



Key Features

Satin stainless steel 316 cover /
Aluminium body

Recessed / 3W CREE XPE / 3000K

Operating current: 700mA

Average lumens 90

Total lumens without cover 275

Driver supplied separately
Fittings must be wired in series

Installation tube must be used for
2000kg drive over rating



IPR-PICRSS



IPR-PICRSS

Driver:
Supplied separately
See page 190



piccadilly round IP67

IPR-PICRSS

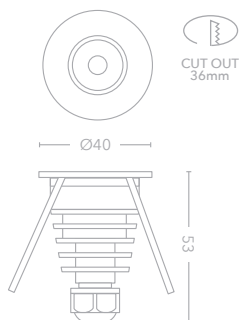

Includes
installation tube

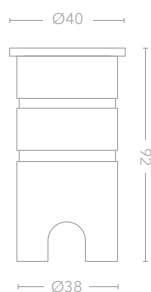

Key Features

Satin stainless steel 316 cover /
Aluminium body

3W CREE XPE / 3000K

Operating current: 700mA

175 lumens

Beam angle: 20°

Driver supplied separately
Fittings must be wired in series



IPR-PADRSS15 / IPR-PADRSS30



IPR-PADSSS15 / IPR-PADSSS30



IPR-PADRSS15



IPR-PADSSS15

Driver:
Supplied separately
See page 190

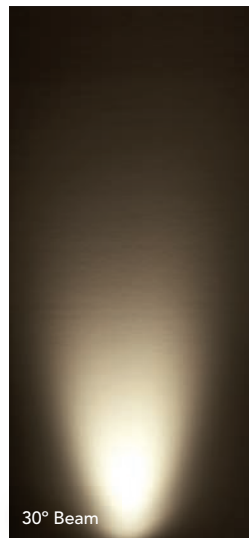

30° Beam

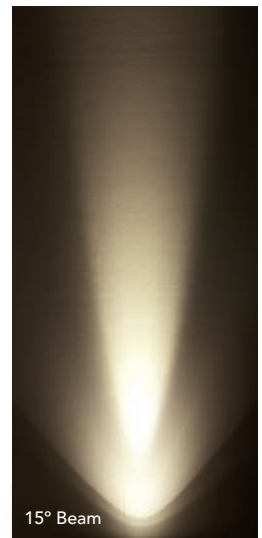

15° Beam

paddington round IP67

IPR-PADRSS15 ■ IPR-PADRSS30 ■ IPR-PADSSS15 ■ IPR-PADSSS30 ■

15° Beam

30° Beam



paddington square IP67

15° Beam

30° Beam

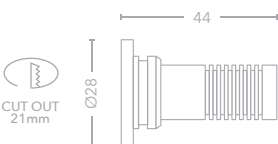
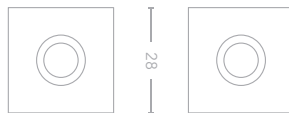

Includes installation tube



Key Features

Satin stainless steel 316 cover / Aluminium body

1W CREE XPE / 3000K

90 lumens

Beam angle: 15° or 30°

Driver supplied separately
Fittings must be wired in series

Spring clip supplied for installation in cavities





IPR-EUSSS



IPR-EUSSS



IPR-HOODSS



IPR-HOODSS

euston 230V

IPR-EUSSS  400 lumens

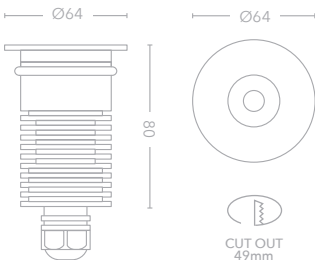

hood 230V

IPR-HOODSS  285 lumens

Includes installation tube

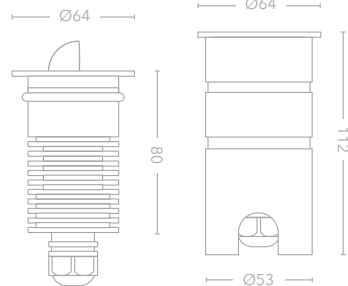

Key Features

Satin stainless steel 316 cover / Aluminium body

6W COB LED / 3000K

Operating current: 220-240V

Beam angle: 24°

Power factor 0.6

Integral driver

Installation tube included



sapporo square

OD-SAPS-GW ■ / □

1.1W SMD LED

45 lumens

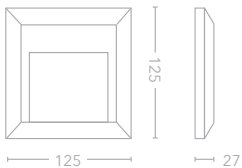

NEW



CLASS 2



IP 65

Key Features

Dark grey and white covers
supplied in the box

PC / ABS material

3000K

Corrosion resistant

Surface mounted

Vandal resistant materials

Interchangeable covers



NEW

OD-SAPL-GW



NEW

OD-SUZ-GW

sapporo long

NEW

OD-SAPL-GW ■ / □

3.5W SMD LED

265 lumens

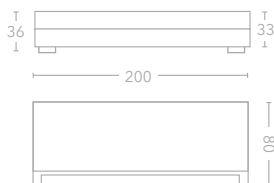

suzuka slot

NEW

OD-SUZ-GW ■ / □

3W SMD LED

310 lumens



CLASS 2



IP 65

Key Features

Dark grey and white covers supplied in the box

PC / ABS material

3000K

Corrosion resistant

Surface mounted

Vandal resistant materials

Interchangeable covers





OD-YOK



OD-YOK

OD-YOKS

yokohama

OD-YOK ■
6W SMD LED
320 lumens

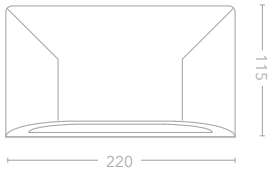

yokohama sensor

OD-YOKS ■
6W SMD LED
160° Sensor
320 lumens

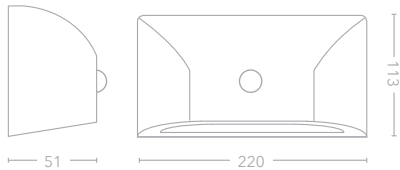

Key Features

- Dark Grey PC ABS /
- Opal PC diffuser
- 3000K
- Power factor 0.4
- Corrosion resistant
- Surface mounted
- Vandal resistant materials



OD-CHIBA



OD-CHIBA



Interchangeable covers

chiba duo

OD-CHIBA ■
12.5W SMD LED
1040 lumens

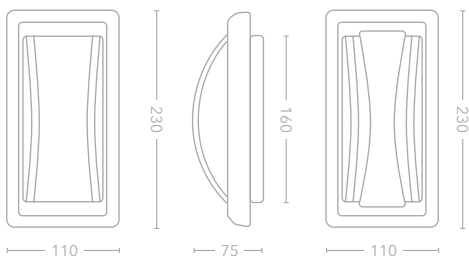

CLASS 2



IP 65

Key Features

Dark Grey PC ABS /
Opal PC diffuser

3000K

Power factor 0.6

Wall or ceiling mounted

Vertical or horizontal

Corrosion resistant

Base comes with two covers

Vandal resistant materials



OD-TOKYO



OD-TOKYO

tokyo

OD-TOKYO ■
12W SMD LED
450 lumens

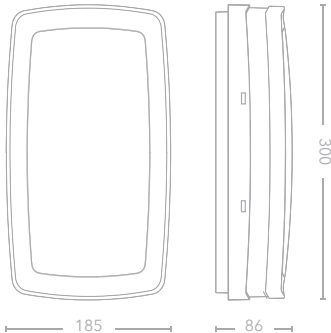

CLASS 2



IP
54

Key Features

Dark Grey PC ABS /
Opal PC diffuser

3000K

Power factor 0.6

Wall or ceiling mounted
Vertical or horizontal

Corrosion resistant

Vandal resistant materials



OD-KOBL

OD-KOBL

kobe large

OD-KOBL ■
21W SMD LED
1260 lumens

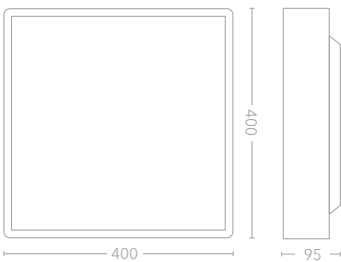

kobe medium

OD-KOBL ■
16W SMD LED
1030 lumens

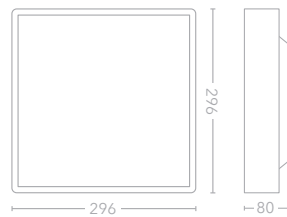

CLASS 2



IP
54

Key Features

Dark Grey PC ABS /
Opal PC diffuser

3000K

Power factor 0.9

Wall / Ceiling mounted

Corrosion resistant

Vandal resistant materials



OD-KYOL



OD-KOBM



OD-KYOS

kyoto large

OD-KYOL ■

28W SMD LED

2090 lumens

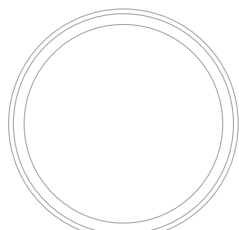

Ø360

47

kyoto medium

OD-KYOM ■

18W SMD LED

1320 lumens

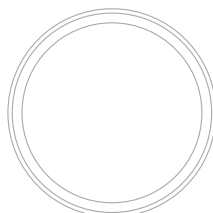

Ø300

44

kyoto small

OD-KYOS ■

15W SMD LED

930 lumens

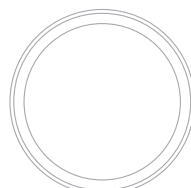

Ø260

44



All bathroom lighting installations must comply to the guidelines set out in Amendment 1 of the 17th edition of the IEE Wiring Regulations (BS7671). The bathroom is divided into zones, with prescribed minimum IP ratings for the light fittings in each zone.

IP rating = Ingress Protection rating.

zone 0

The area inside the bath or shower tray. Fittings must be rated at IPX7 or higher (protected against immersion in water).

zone 1

The area above the bath or shower up to a height of 2.25 metres. Fittings must be rated at IPX5 or higher (protected from jets of water).

zone 2

Covers an area 0.6 metres wide immediately next to, and all around Zone 1. The 60cm area around washbasins should also be treated as zone 2. The minimum rating is IPX4. If there is a likelihood of water jets being used for cleaning purposes in Zone 2, a minimum of IPX5 is required.

outside zone

Covers any area outside Zones 0, 1 and 2. There is no IP requirement in this zone. Bathrooms are allowed to contain a socket outlet, this must be located 3 metres outside Zone 1. Lighting circuits and any socket-outlet circuit in a room containing a bath and/or shower must be provided with 30mA RCD protection.



BA-M-ACQUA



acqua

BA-M-ACQUA

18.7W SMD LED

1326 lumens



CLASS 2



SWITCH



IP
44



DE-MISTER

Key Features

Frosted / Mirrored glass

Bathroom zone 2

3000K

Removable pull cord

Demister pad

bathroom index

downlights



marker lights and mini spots



ceiling



CORONA

Pages 92-93



SELENE

Pages 54-55



BANDA / ANDAMAN

Pages 88-89

wall



VERITAS / VENTI

Pages 110-111



SIMPLON

Page 35

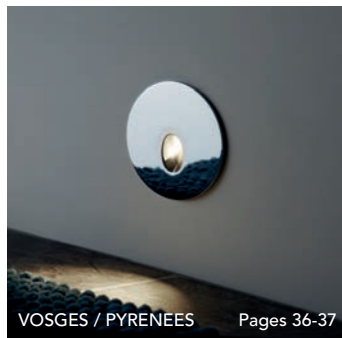

VOSGES / PYRENEES

Pages 36-37

accessories



MOD1WIP

1w IP65 350mA LED module

1W CREE XPE 350mA
Beam angle: 30°
95 lumens

MOD1WIP 3000K ●
MOD1WIP-2700 2700K ●



MOD1WIP230V

1w IP65 230V LED module

1W CREE XPE 350mA
Beam angle: 30°
95 lumens

MOD1WIP230 3000K ●
MOD1WIP230V-2700 2700K ●



MOD1W

1w 350mA LED module

1W CREE XPE 350mA
Beam angle: 30°
95 lumens

MOD1W 3000K ●
MOD1W-2700 2700K ●

constant current drivers

Item no.	Current	Min. load	Max. load	TRIAC dimmable	IP Rating	Power factor	Dimensions L x W x H (mm)	Tails / Screw terminals
DR350-3TD	350mA	2W	3W	Yes	IP65	0.9	38 x 27 x 21	Tails
DR350-7	350mA	1W	7W	No	IP65	0.4	60 x 35 x 23	Tails
DR350-9TD	350mA	2W	9W	Yes	IP20	0.9	110 x 45 x 28	Screw terminals
DR350-18TD	350mA	10W	18W	Yes	IP20	0.9	165 x 52 x 25	Screw terminals
DR700-3	700mA	1W	3W	No	IP65	0.4	38 x 27 x 21	Tails
DR700-9	700mA	3W	9W	No	IP65	0.5	60 x 35 x 23	Tails
DR700-18TD	700mA	6W	18W	Yes	IP20	0.9	110 x 45 x 28	Screw terminals
DR700-36TD	700mA	20W	36W	Yes	IP20	0.9	165 x 52 x 25	Screw terminals

Wiring diagram

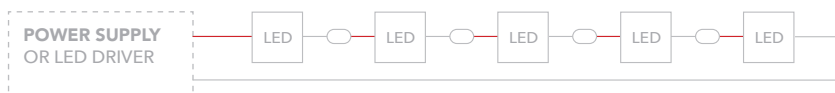

* NOTE: All these drivers must be wired in series

product name index

Acqua	187	Drum 40	155	Lino	81	Simplon	30
Andaman	89	Drum 58	155	London Bridge	107	Simplon IP65	35
Andromeda Ceiling	85	Drum Diffusers	155	Lyra	90	Slim Trim Adjustable	14-15
Andromeda Track	44	Eternity	76-77	Mabillon	120	Slim Trim IP65	16-17
Ankle Light	39	Europe	117	Mayfair Adjustable	159	Slim Trimless	24
Apollo Pendant	83	Euston	177	Medium Oval	154	Slim Trimless FR	25
Apollo Spotlights	56-57	Farringdon	171	Mini Projector	127	Sloane	100-101
Apollo Track	42	Fenchurch	134	Mirabeau	119	Small Oval	152
Ara	72-73	Gemini	46	Monceau	119	Small Rectangle	153
Artemis	83	Glacier	18	Moon	51-53	Southwark	103
Athena	82	Grid	20-23	Odeon	125	Strand Adjustable	159
Avron	121	Grosvenor	168	Olympia	146-147	Suzuka	179
Banda	88	Grosvenor II	169	Open Crescent	152	Telegraphe	27
Berkeley	161	Halkin	105	Open Square	153	Tokyo	183
Blanche LED	32	Hepburn	78-79	Opera	125	Track Heads	42-46
Blanche GU10	34	Hera	13	Orbit	75	Track	48
Blob	94-95	Holborn	38	Orcus	86	Track Kits	48
Boulogne LED	32	Holborn Anti Glare	39	Orion	45	Pendant Adapter	47
Cadet	123	Honos	84-85	Ovo	113	Track Accessories	49
Cambronne	124	Hood	177	Paddington	175	Trocadero	27
Chelsea	139	Hoxton	38	Pegasus	43	Tube	113
Chiba	182	Ice	104	Piccadilly	174	Universal Shades	128-129
Claridges	163	Jupiter	59	Pimlico	130-131	Vavin	109
Clip	80	Kensington	145	Pimlico Plus	132-133	Venti	111
Compass	74	Kobe	184	Plot	173	Veritas	110
Concorde	116	Kyoto	185	Pyrenees	30	Victoria	135
Cone	152	Lanesborough	163	Pyrenees IP65	37	Victoria LED	136-137
Connaught	165	Large Oval	154	Renne	28-29	Voltaire	123
Corona	93	Large Rectangle	153	Rome	26	Vosges IP65	36
Diana	39	LED Module	190	Sanderson	167	Vulcan	91
Dorchester	166	LED Strip	62, 64	Sapporo	178-179	Waldorf	165
Drivers / Constant Current	190	LED Strip Drivers	68-69	Saturn	87	Wall Washer	19
Drivers / Constant Voltage	68-69	LED Strip Profile	66-67	Selene	54-55	X-Large Rectangle	154
Drum 15	152	LED Strip Connectors	63, 65	Sentier	119	Yokohama	181
Drum 30	155	Libra Table & Floor	143	Shades	152-155	Zeus	11-12
		Libra Track	45	Shade Suspension	96-97		
				Shoreditch	103		

product code index

AM-CORO	93	FL-BLOB	95	OD-CLA	163	PL-EURO	117
AM-VUL	91	FL-ETE55	77	OD-CON	165	PL-GRID1FR	23
BA-M-ACQUA	187	FL-LYRA	90	OD-DOR	166	PL-MABIL	120
BA-VEN	111	FL-SAT	87	OD-FARR	171	PL-MIRAB	119
BA-VER	110	FS-KEN	145	OD-GRO	168	PL-MONCE	119
CE-AND	85	FS-LIB	143	OD-GRO2	169	PL-ODEON	125
CE-HEPL	79	FS-OLY	147	OD-KOB	184	PL-OPERA	125
CE-HEPR	78	IPR-ANK	39	OD-KYO	185	PL-PYREN	30
CE-HEPS	78	IPR-EUSSS	177	OD-LAN	163	PL-REN1	28
CE-HONR	85	IPR-HOL	38	OD-MAY	159	PL-REN2	29
CE-HONSQ	85	IPR-HOLSSAG	39	OD-SAN	167	PL-RENWW	29
CE-HONSQ2	84	IPR-HOODSS	177	OD-SAPL	179	PL-ROM	26
CE-LINO	81	IPR-HOX	38	OD-SAPS	178	PL-SENTI	119
CE-ORC	86	IPR-PAD	175	OD-STR	159	PL-SIMPL	30
DL-DIA	39	IPR-PIC	174	OD-SUZ	179	PL-SLIMFRW	25
DL-GLAR	18	IPR-PLOT	173	OD-TOKYO	183	PL-SLIMIPW	24
DL-GRID1	20	IPR-WR	37	OD-WAL	165	PL-SLIMW	24
DL-GRID1FR	22	IPR-WSL	35	OD-YOK	181	PL-TELEG	27
DL-GRID2	21	IPR-WVO	36	PE-APO	83	PL-TROCA	27
DL-GRID2FR	22	LED-PROJ1W	127	PE-ARA100	72	PL-VOLT	123
DL-GRID3	21	LST-14	64	PE-ARA60	73	SH-CO	152
DL-MOD	13	LST-4	62	PE-ART	83	SH-CR	152
DL-SLIM	15	LST-CON1	65	PE-ATH	82	SH-DIF	155
DL-SLIMFRW	14	LST-CON2	65	PE-BLOB	94	SH-DR15	152
DL-SLIMIP	17	LST-CON3	63	PE-CLIP	80	SH-DR30	155
DL-SLIMIPFR	16	LST-CON4	63	PE-COM2	74	SH-DR40	155
DL-SLIMSQ	15	LST-DR	69	PE-ETE55	77	SH-DR58	155
DL-UNI	12	LST-DRD	68	PE-ETE78	76	SH-OV	152
DL-WASH	19	LST-PRO-COR	67	PE-LYRA	90	SH-OVL	154
DL-WWW	19	LST-PRO-HS	66	PE-ORB120	75	SH-OVM	154
DL-ZEUS3K	11	LST-PRO-PL1	66	PL-AVRON	121	SH-P1	97
DL-ZEUSGU10	12	LST-PRO-R1	66	PL-BLA	32	SH-P3	96
DL-ZEUSSUNSET	11	LST-PRO-SM1	67	PL-BLAGU10	34	SH-RL	153
DR350	190	MOD1W	190	PL-BOU	32	SH-RS	153
DR700	190	MOD1WIP	190	PL-CADET	123	SH-RXL	154
FL-ADM	89	OD-BER	161	PL-CAMBR	124	SH-SF3	96
FL-BAN	88	OD-CHIBA	182	PL-CONC	116	SH-SQO	153

SH-UC	129	TR-GEM	46
SH-UD	128	TR-LC	49
SH-UR	129	TR-LE	49
SH-US	128	TR-LIB	45
SH-UWB	128	TR-MJ	49
SH-VICLED	136	TR-ORI	45
SH-VICLEDR	137	TR-PEG	43
SH-WBFEN-SN	134	TR-PEN	47
SH-WBPIM	130	TR-SUS	49
SH-WBPIMP	132	TR-T1	48
SH-WBPIMPR	133	TR-T2	48
SH-WBPIMR	131	TR-TC	49
SH-WBVIC	135	TR-XC	49
SH-WBVICR	135	WL-CHE	139
SP-APO1	57	WL-CHER	139
SP-APO2	56	WL-HALK	105
SP-APO3	56	WL-ICE	104
SP-APOR	57	WL-LB	107
SP-JUP	59	WL-OV25	113
SP-MOO1	51	WL-SHO	103
SP-MOO2	53	WL-SLO	100
SP-MOO3	52	WL-SOU	103
SP-MOO3L	52	WL-TU16	113
SP-MOO4	53	WL-VAV	109
SP-MOOR	51		
SP-SEL3L	55		
SP-SEL3R	54		
TA-KEN	145		
TA-LIB	143		
TA-OLY	147		
TA-OLY-USB	146		
TR-1	48		
TR-2	48		
TR-AND	44		
TR-APO	42		
TR-CC	49		
TR-EC	49		

Additional information

Any typographical, clerical or other error or omission in any sales literature, quotation, price list, acceptance of offer, invoice or other document or information issued by the Company shall be subject to correction without any liability on the part of the Company. Goods supplied may vary in detail from the illustrations, drawings, measurements and descriptions set out in the Company's sales literature, which are approximate and for guidance only and will not form part of the Contract. Colour finishes will be maintained as accurately as possible but matching cannot be guaranteed. All terminology used in the Company's sales literature is, subject to these Conditions, that as understood by general usage in the trade. For full terms and conditions of sale consult your distributor.

guide to symbols



COMPATIBLE WITH HERA MODULE pg 15



CLASS 1

Class I fittings must have their chassis connected to an electrical earth (ground).



CLASS 2

Class II or double insulated electrical fittings does not require a safety connection to electrical earth (ground).



CLASS 3

Class III fittings are designed to be supplied from a separated / safety extra-low voltage (SELV) power source.



IP 44

(4) Objects greater than 1 mm, e.g. tools, wires / small wires
(4) Protected against water sprayed from all directions - limited ingress permitted.



IP 54

(5) Protected against dust - limited ingress (no harmful deposits)
(4) Protected against water sprayed from all directions - limited ingress permitted.



IP 65

(6) Totally protected against dust (Dust-tight)
(5) Protected against low pressure jets of water from all directions - limited ingress permitted.



IP 67

(6) Totally protected against dust (Dust-tight)
(7) Protection against the effects of immersion between 15cm - 1 metre



SWITCH

The product has an electrical ON/OFF switch incorporating a spring-loaded rocker.



DIMMABLE

The fitting can be used with a compatible dimming light switch.



GLASS

The fitting contains fragile glass parts.



CUT OUT 75mm

The electrical parts of the fitting require a ceiling cut out.



DRIVE OVER

The outdoor, inset floor mounted fitting can be driven over by a vehicle, up to 2000kg weight limit.



FIRE RATED

Fire rated downlights restore the fire integrity of a ceiling with recessed ceiling lights installed.



320kg WALKOVER

The outdoor, inset floor mounted fitting can be walked over by a flat foot, up to 320kg weight limit.



350mA

A unit of electric current (mA) equal to one thousandth of an Amp.



24 VOLTS

The SI unit of electromotive force, the Volt (V) is a standard for extra low voltage power systems.

shade colours

C

Coconut colour cotton material lamp shade.

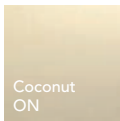
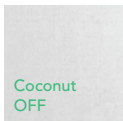

M

Mushroom colour cotton material lamp shade.

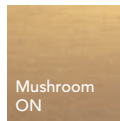
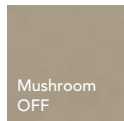

G

Grey seal colour cotton material lamp shade.

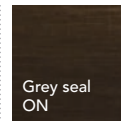
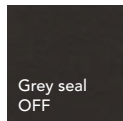

B

Black colour cotton material lamp shade.

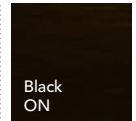
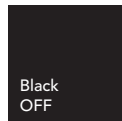

fitting finishes



AB

Antique brass finish for fixtures & fittings.

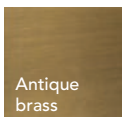

SN

Satin nickel finish for fixtures & fittings.

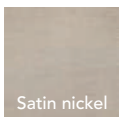

CP

Polished chrome finish for fixtures & fittings.

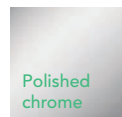

SS

Stainless steel finish for fixtures & fittings.



B

Black finish for fixtures & fittings.

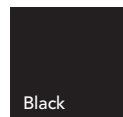

W

White finish for fixtures & fittings.



GR

Graphite grey finish for fixtures & fittings.



SG

Silver grey finish for fixtures & fittings.



gids voor symbolen



COMPATIBEL MET HERA-MODULE pg 15



KLASSE 1

Klasse 1 armaturen moeten in bezit zijn van een aardeverbinding.



KLASSE 2

Klasse 2 armaturen hoeven geen aardeverbinding te bezitten.



KLASSE 3

Klasse 3 armaturen zijn ontworpen voor een externe laagspanningsvoeding.



IP 44

IP44 (4) Objecten groter dan 1mm zoals bv kabels / armaturen zijn (4) beschermd tegen water nevel vanuit elke hoek. Beperkt indringen toegestaan.



IP 54

IP55 (5) Beschermd tegen stof - beperkt indringen toegestaan en niet schadelijk. (5) Beschermd tegen water nevel vanuit elke hoek. Beperkt indringen toegestaan.



IP 65

IP65 (6) Compleet beschermd tegen stof (5) Beschermd tegen lichte waterstralen, vanuit elke hoek. Beperkt indringen toegestaan.



IP 67

IP67 (6) Compleet beschermd tegen stof (7) Beschermd tegen het effect van onderdompeling 15cm tot 1m.



SCHAKELAAR

Dit product heeft een elektrische aan/uit schakelaar, in combinatie met een veerbelaste tuimelaar.



DIMBAAR

Dit armatuur is geschikt om te dimmen, in combinatie met dimbare lichtbron.



GLAS

Dit armatuur bevat kwetsbare glazen onderdelen.



OPENING 75mm

Voor dit armatuur is een opening in het plafond vereist.



OVERRIJDBAAR

Geschikt voor plaatsing in de vloer, met een drukbelasting tot 2000 kilo.



BRANDWEREND

Dit armatuur beschikt over een brandwerende functie.



320kg OVERLOOPBAAR

Geschikt voor plaatsing in de vloer, met een drukbelasting tot 320 kilo.



350mA

Een eenheid van elektrische stroom gelijk aan een duizendste van een Amp.



24 VOLTS

De SI-eenheid van elektromotorische kracht, is volt. Dit is standaard voor extra laagspanningssystemen.

lampenkappen kleuren

C

Coconut
kleur katoen materiaal
lampenkap.



Coconut
UIT

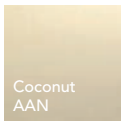

Coconut
AAN

M

Mushroom
kleur katoen materiaal
lampenkap.

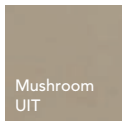

Mushroom
UIT

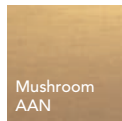

Mushroom
AAN

G

Grey seal
kleur katoen materiaal
lampenkap.

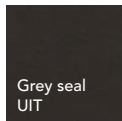

Grey seal
UIT

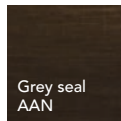

Grey seal
AAN

B

Black
kleur katoen materiaal
lampenkap.

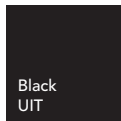

Black
UIT

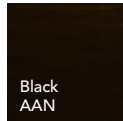

Black
AAN

armatuur kleuren



AB

Antiek messing afwerking voor armaturen en fittingen.



SN

Satijn messing afwerking voor armaturen en fittingen.



CP

Gepolijst messing afwerking voor armaturen en fittingen.



SS

RVS messing afwerking voor armaturen en fittingen.



B

Zwart messing afwerking voor armaturen en fittingen.



W

Wit messing afwerking voor armaturen en fittingen.



GR

Grafiet messing afwerking voor armaturen en fittingen.



SG

Zilver grijs messing afwerking voor armaturen en fittingen.

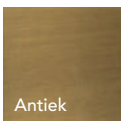

Antiek

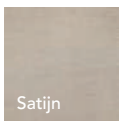

Satijn



Gepolijst



RVS

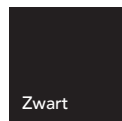

Zwart

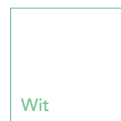

Wit

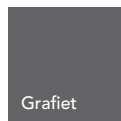

Grafiet

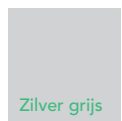

Zilver grijs

guide des symboles



COMPATIBLE AVEC HERA MODULE pg 15



CLASSE 1

Dispositifs de Classe I : Le châssis doit être connecté à une prise de terre.



CLASSE 2

Classe II ou double isolation du câblage électrique connexion de sécurité à une prise de terre électrique non obligatoire.



CLASSE 3

Les dispositifs de classe III sont conçus pour être alimentés par une source d'alimentation séparée en basse tension (SELV).



IP 44

(4) Protégé contre objets de plus de 1 mm, exemple : outils, fils électriques
(4) Protégé contre l'eau pulvérisée dans toutes les directions - pénétration limitée.



IP 54

(5) Protégé contre la poussière - pénétration limitée (pas de dépôts)
(4) Protégé contre l'eau pulvérisée dans toutes les directions - pénétration limitée.



IP 65

(6) Totalement protégé contre la poussière (étanche à la poussière)
(5) Protégé contre les jets basse pression dans toutes les directions - pénétration limitée.



IP 67

(6) Totalement protégé contre la poussière (étanche à la poussière)
(7) Protection contre les effets de l'immersion entre 15cm - 1 mètre.



INTER

Le produit possède un interrupteur électrique interrupteur ON/OFF incorporant une bascule à ressort.



DIMMABLE

Le dispositif peut être utilisé avec un appareil variateur de lumière compatible.



VERRES

Le dispositif contient des pièces fragiles.



DÉCOUPE 75mm

L'installation électrique de l'appareil nécessitent une découpe.



DRIVE OVER

L'encasté de sol peut être écrasé par un véhicule, jusqu'à une limite de poids de 2000 kg.



FIRE RATED

Ignifuge - Protection au feu - prévient le risque d'incendie dans un plafond.



320kg WALKOVER

L'armature de l'encastée de sol résiste jusqu'à un poids de 320 kg.



350mA

Unité de courant électrique (mA) égale à un millième d'ampère.



24 VOLTS

L'unité SI de la force électromoteur, le Volt (V) est un standard pour les puissances basse tension.

couleurs abajour

C

Coconut
Abat-jour en coton de couleur.

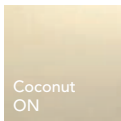
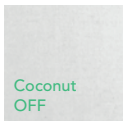

M

Mushroom
Abat-jour en coton de couleur.

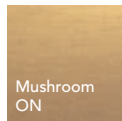
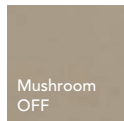

G

Grey seal
Abat-jour en coton de couleur.

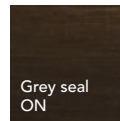
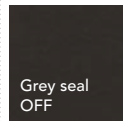

B

Black
Abat-jour en coton de couleur.

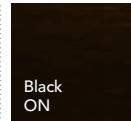
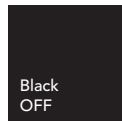

finitions des luminaires



AB

Finition en Laiton antique pour les luminaires et les composants.



SN

Finition en Nickel Satiné pour les luminaires et les composants.



CP

Finition en Chrome Poli pour les luminaires et les composants.



SS

Finition en Acier Inoxidable pour les luminaires et les composants.



B

Finition en Noir pour les luminaires et les composants.



W

Finition en Blanc pour les luminaires et les composants.



GR

Finition en Gris graphite pour les luminaires et les composants.



SG

Finition en Gris argenté pour les luminaires et les composants.

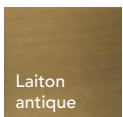

Laiton antique



Nickel satiné

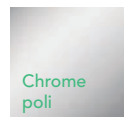

Chrome poli



Acier inoxydable

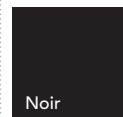

Noir



Blanc

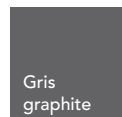

Gris graphite



Gris argenté



© 2021 All Rights Reserved Searchlight Electric Ltd

project
collection

21/22

www.projectcollection.co.uk

Project Collection

Sidney House

900 Oldham Road

Manchester

M40 2BS

United Kingdom

Benelux Showroom / Office

Hoogjens 1

4254 XV Sleeuwijk

Netherlands

+31 85-3036527

T +44 (0) 161 203 3456

E info@projectcollection.co.uk

